

Copyright

This publication, including all photographs, illustrations and software, is protected under international copyright laws, with all rights reserved. Neither this manual, nor any of the material contained herein, may be reproduced without written consent of the author.

© Copyright February, 2006

Disclaimer

The information in this document is subject to change without notice. The manufacturer makes no representations or warranties with respect to the contents hereof and specifically disclaims any implied warranties of merchantability or fitness for any particular purpose. The manufacturer reserves the right to revise this publication and to make changes from time to time in the content hereof without obligation of the manufacturer to notify any person of such revision or changes.

Trademark Recognition

Kensington is a U.S. registered trademark of ACCO Brand Corporation with issued registrations and pending applications in other countries throughout the world.

All other product names used in this manual are the properties of their respective owners and are acknowledged.

Important Safety Information

Congratulations on purchasing the DLP projector!

Important:

It is strongly recommended that you read this section carefully before using the projector. These safety and usage instructions will ensure that you enjoy many years of safe use of the projector. Keep this manual for future reference.

Symbols Used

Warning symbols are used on the unit and in this manual to alert you of hazardous situations.

The following styles are used in this manual to alert you to important information.

Note:

Provides additional information on the topic at hand.

Important:

Provides additional information that should not be overlooked.

Caution:

Alerts you to situations that may damage the unit.

Warning:

Alerts you to situations that may damage the unit, create a hazardous environment, or cause personal injury.

Throughout this manual, component parts and items in the OSD menus are denoted in bold font as in this example:

“Push the **Menu** button on the remote control to open the **Main** menu.”

Remote Control

Some remote controls have a laser for pointing out items on a screen.

DANGER: Do not point the laser in the eyes. Doing so can damage the eyes permanently.

General Safety Information

- ⌚ Do not open the unit case. Aside from the projection lamp, there are no user-serviceable parts in the unit. For servicing, contact qualified service personnel.
- ⌚ Follow all warnings and cautions in this manual and on the unit case.
- ⌚ The projection lamp is extremely bright by design. To avoid damage to eyes, do not look into the lens when the lamp is on.
- ⌚ Do not place the unit on an unstable surface, cart, or stand.
- ⌚ Avoid using the system near water, in direct sunlight, or near a heating device.
- ⌚ Do not place heavy objects such as books or bags on the unit.

Power Safety

- ⌚ Only use the supplied power cord.
- ⌚ Do not place anything on the power cord. Place the power cord where it will not be in the way of foot traffic.
- ⌚ Remove the batteries from the remote control when storing or not in use for a prolonged period.

Replacing the Lamp

Replacing the lamp can be hazardous if done incorrectly. Refer to “Replacing the Projection Lamp” on page 38 for clear and safe instructions for this procedure. Before replacing the lamp:

- ⌚ Unplug the power cord.
- ⌚ Allow the lamp to cool for about one hour.

Spent Lamp Management

- ⌚ This product contains a metal halide lamp, which contains mercury. Dispose of it as required by local ordinances and regulations.
- ⌚ The USA restricts or prohibits the disposal of some or all mercury containing lamps in the municipal waste stream. Please visit www.lamprecycle.org for more information on specific state disposal requirements and recycling facilities.
- ⌚ The following states have laws that deal with information that wholesalers must provide to contractors for lamp disposal.
Connecticut
Maine
Minnesota
Rhode Island
- ⌚ For users in Connecticut, please call our toll free number 1-888-657-5267 to place an order for the delivery of a kit for returning a used lamp. The kit includes a box for the lamp, tape, and a return shipping label. To return a lamp:
 1. Place the lamp in the box, complete the enclosed form, and seal the box with the provided tape.
 2. Affix the return shipping label to the box and call 1.800.463.3339 FedEx Ground Service for box pickup.

Cleaning the Projector

- ⌚ Unplug the power cord before cleaning. Refer to “Cleaning the Projector” on page 41.
- ⌚ Allow the lamp to cool for about one hour.

Regulatory Warnings

Before installing and using the projector, read the regulatory notices in the “Regulatory Compliance” section on page 55.

Main Features

- *Lightweight unit, easy to pack away and transport*
- *Compatible with all major video standards including NTSC, PAL, and SECAM*
- *A high brightness rating allows for presentations in daylight or in lit rooms*
- *Supports resolutions up to UXGA at 16.7 million colors to deliver crisp, clear images*
- *Flexible setup allows for front, rear, and ceiling projections*
- *Line-of-vision projections remain square, with advanced keystone correction for angled projections*
- *Input source automatically detected*

About this manual

This manual is intended for end users and describes how to install and operate the DLP projector. Wherever possible, relevant information—such as an illustration and its description—has been kept on one page. This printer-friendly format is both for your convenience and to help save paper, thereby protecting the environment. It is suggested that you only print sections that are relevant to your needs.

Table of contents

GETTING STARTED..... 1

 PACKING CHECKLIST..... 1

 VIEWS OF PROJECTOR PARTS..... 2

Front-right View..... 2

Top View—On-screen Display (OSD) Buttons and LEDs..... 3

Side View Connectors..... 4

Projector LED Descriptions..... 5

Rear View..... 6

Bottom View..... 7

 REMOTE CONTROL PARTS 8

 REMOTE CONTROL OPERATING RANGE..... 10

 PROJECTOR AND REMOTE CONTROL BUTTONS..... 10

SETUP AND OPERATION..... 11

 INSERTING THE REMOTE CONTROL BATTERIES..... 11

 CONNECTING INPUT DEVICES..... 12

 STARTING AND SHUTTING DOWN THE PROJECTOR..... 14

 ADJUSTING THE PROJECTOR LEVEL..... 16

 ADJUSTING THE ZOOM, FOCUS AND KEYSTONE..... 17

 ADJUSTING THE VOLUME 18

ON-SCREEN DISPLAY (OSD) MENU SETTINGS..... 19

 OSD MENU CONTROLS..... 19

Navigating the OSD..... 19

 SETTING THE OSD LANGUAGE..... 20

 PICTURE MENU..... 21

Picture Menu Functions Available for Connected Source..... 23

 ADVANCE MENU 24

Advance Menu Functions Available for Connected Source..... 25

 SETUP MENU 27

Setup Menu Functions Available for Connected Source..... 29

 AUDIO MENU..... 31

Audio Menu Functions Available for Connected Source..... 31

 WINDOW MENU..... 32

 COLORMGR MENU 34

 SERVICE MENU..... 35

 NETWORK MENU..... 37

MAINTENANCE AND SECURITY..... 38

 REPLACING THE PROJECTION LAMP..... 38

Resetting the Lamp..... 40

 CLEANING THE PROJECTOR..... 41

Cleaning the Lens..... 41

Cleaning the Case..... 41

 USING THE KENSINGTON® LOCK..... 42

 CEILING INSTALLATION..... 42

Securing the Mount to the Ceiling..... 42

Using Support Cables..... 43

TROUBLESHOOTING..... 44

 COMMON PROBLEMS AND SOLUTIONS 44

 TIPS FOR TROUBLESHOOTING..... 44

 LED ERROR MESSAGES 45

 IMAGE PROBLEMS..... 45

 LAMP PROBLEMS..... 46

 REMOTE CONTROL PROBLEMS 46

 AUDIO PROBLEMS 46

 HAVING THE PROJECTOR SERVICED 47

SPECIFICATIONS..... 48

- SPECIFICATIONS..... 48
 - Input Connectors*..... 49
 - Output Connectors*..... 49
 - Control Connectors*..... 49
 - Optional Lens*..... 49
- PROJECTION DISTANCE V.S. PROJECTION SIZE (FOR STANDARD LENS)..... 50
- TIMING MODE TABLE..... 51
- PROJECTOR DIMENSIONS..... 54

REGULATORY COMPLIANCE..... 55

- FCC WARNING..... 55
- CANADA..... 55
- SAFETY CERTIFICATIONS..... 55
- EN 55022 WARNING..... 55

Getting Started

Packing Checklist

Carefully unpack the projector and check that the following items are included:

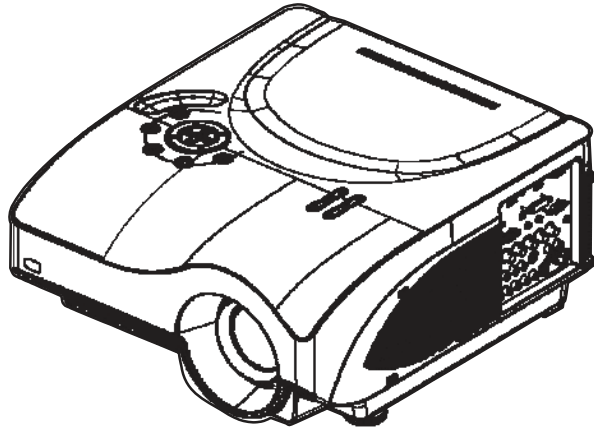

DLP PROJECTOR WITH LENS CAP



*REMOTE CONTROL
(WITH TWO AAA BATTERIES)*

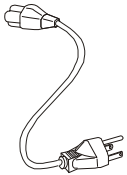

POWER CORD

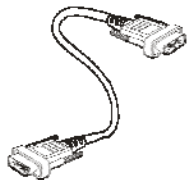

*COMPUTER CABLE
(DB15-DB15)*



CD-ROM (THIS USER'S MANUAL)

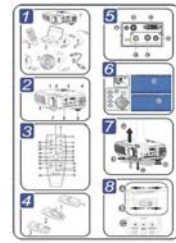

QUICK START GUIDE

Contact your dealer immediately if any items are missing, appear damaged, or if the unit does not work.

Caution:

Avoid using the projector in dusty environments.

Views of Projector Parts

Front-right View

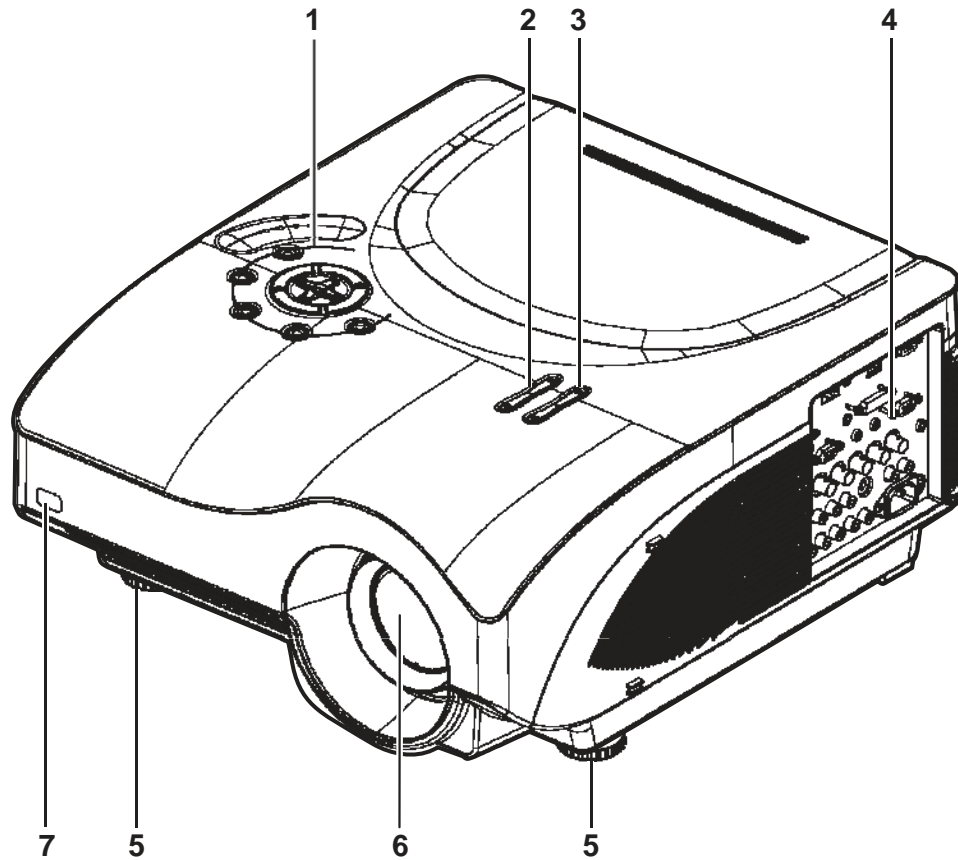

ITEM	LABEL	DESCRIPTION	SEE PAGE:
1.	See “Top View—On-screen Display (OSD) Buttons and LEDs” on page 3.		
2.	Focus	Focuses the projected image	17
3.	Lens zoom	Enlarges the projected image	
4.	See “Side View Connectors” on page 4.		
5.	Height-adjusters	Turn to adjust level of projector	16
6.	Lens	Remove lens cap before use	14
7.	Front IR receiver	Receiver for IR signal from remote control	10

Important:
 Ventilation openings on the projector allow for good air circulation, which keeps the projector lamp cool. Do not obstruct any of the ventilation openings.

Top View—On-screen Display (OSD) Buttons and LEDs

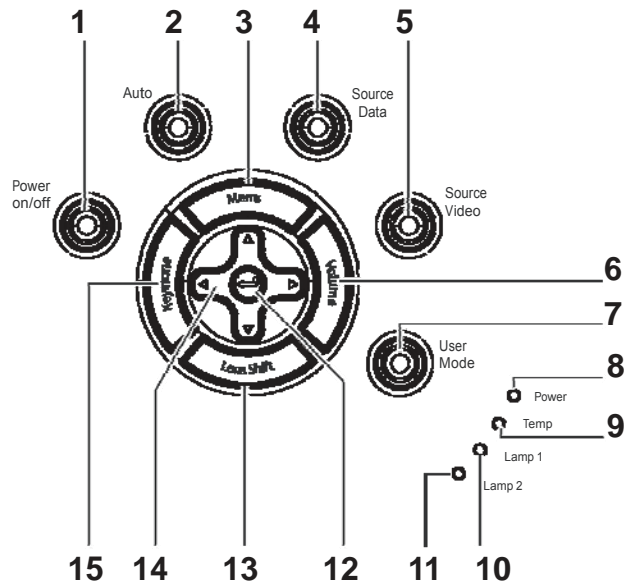

ITEM	LABEL	DESCRIPTION	SEE PAGE:
1.	Power on/off	Turns the projector on or off	14
2.	Auto	Optimizes image size, position, and resolution	
3.	Menu	Opens and exits the OSD	19
4.	Source Data	Detects the data (PC) input device	14
5.	Source Video	Detects the video input device	
6.	Volume	Adjust the volume with LEFT/RIGHT arrow buttons	
7.	User Mode	Open the User mode menu	
8.	Power	See “Projector LED Descriptions” on page 5.	
9.	Temp		
10.	Lamp 1		
11.	Lamp 2		
12.	Enter		Confirm settings in OSD menus
13.	Lens Shift	Adjust the vertical shift of the lens	
14.	Arrow buttons	Navigate and changes settings in the OSD Volume/keystone adjust when OSD off	
15.	Keystone	Adjust the keystone with UP/DOWN arrow buttons	

S ide View Connectors

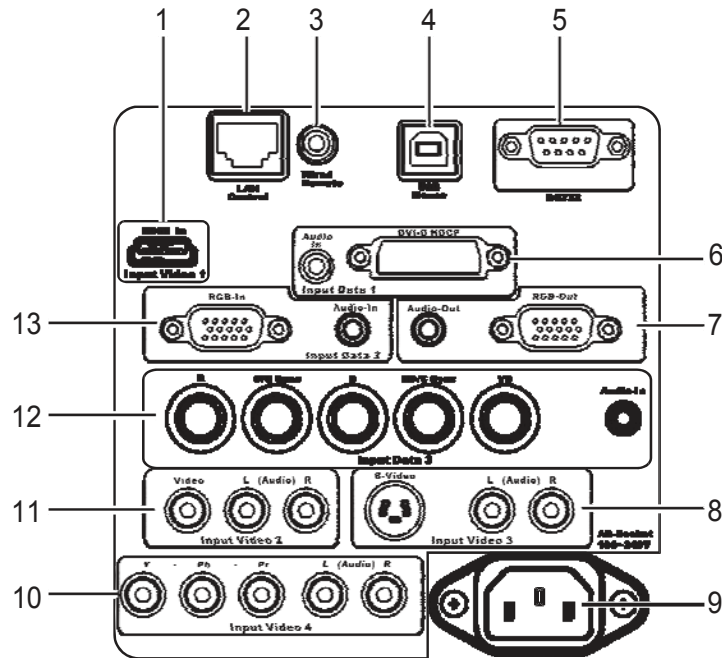

ITEM	LABEL	DESCRIPTION	SEE PAGE:
1.	Input Video 1	Connect an HDMI cable from an HDTV	12
2.	LAN Control	Connect a LAN cable for controlling projector through a PC	
3.	Wired Remote	Connect a wired remote control	
4.	USB Mouse	Connect the USB cable from a computer	
5.	RS232	This is a service port for firmware upgrades.	
6.	Input Data 1	Connect a DVI-D computer cable from a computer	
7.	Audio-Out	Connect an audio cable to external speakers	
	RGB-Out	Connect an RGB cable to an external monitor	
8.	Input Video 3	Connect an S-video cable to the S-video connector Connect an RCA audio connector to L/R audio connectors	14
9.	Power	Connect the supplied power cord	
10.	Input Video 4	Connect an RCA component cable the Y/Pb/Pr connectors Connect an RCA audio connector to L/R audio connectors	12

ITEM	LABEL	DESCRIPTION	SEE PAGE:
11.	Input Video 2	Connect a composite video cable to the Video connector Connect an RCA audio connector to L/R audio connectors	12
12.	Input Data 3	Connect a 5-connector BNC (RGB + VSync + HSync) cable	
13.	Input Data 2	Connect an RGB cable from a computer to RGB-In Connect an audio cable from a computer to Audio-In	

P rojector LED Descriptions

LED	ON (SEE PAGE 14)	OFF (SEE PAGE 14)	FLASHING (SEE PAGE 45)
Power	System ready	Power off	System error
Temp	Standby	Lamp on	Over temperature
Lamp 1	Standby/lamp off	Lamp on	Lamp error
Lamp 2	Standby/lamp off	Lamp on	Lamp error

Rear View

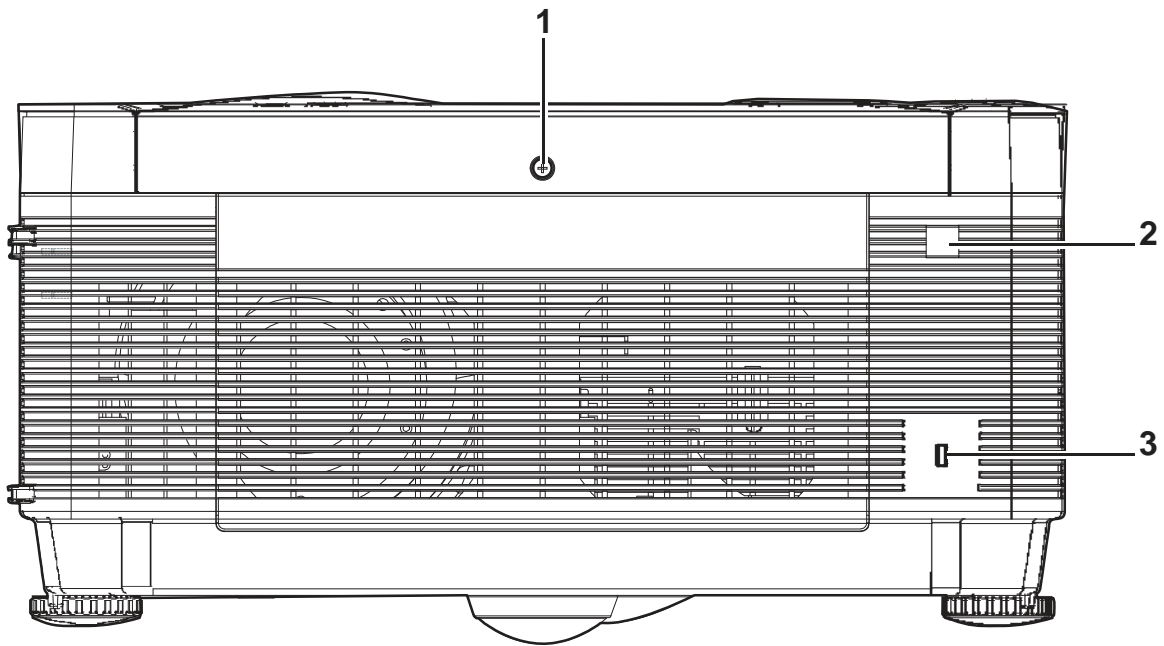

ITEM	LABEL	DESCRIPTION	SEE PAGE:
1.	Cover screw	Loosen to remove lamp cover	38
2.	Rear IR receiver	Receiver for IR signal from remote control	10
3.	Security Lock	Secure to permanent object with a Kensington® Lock system	42

B ottom View

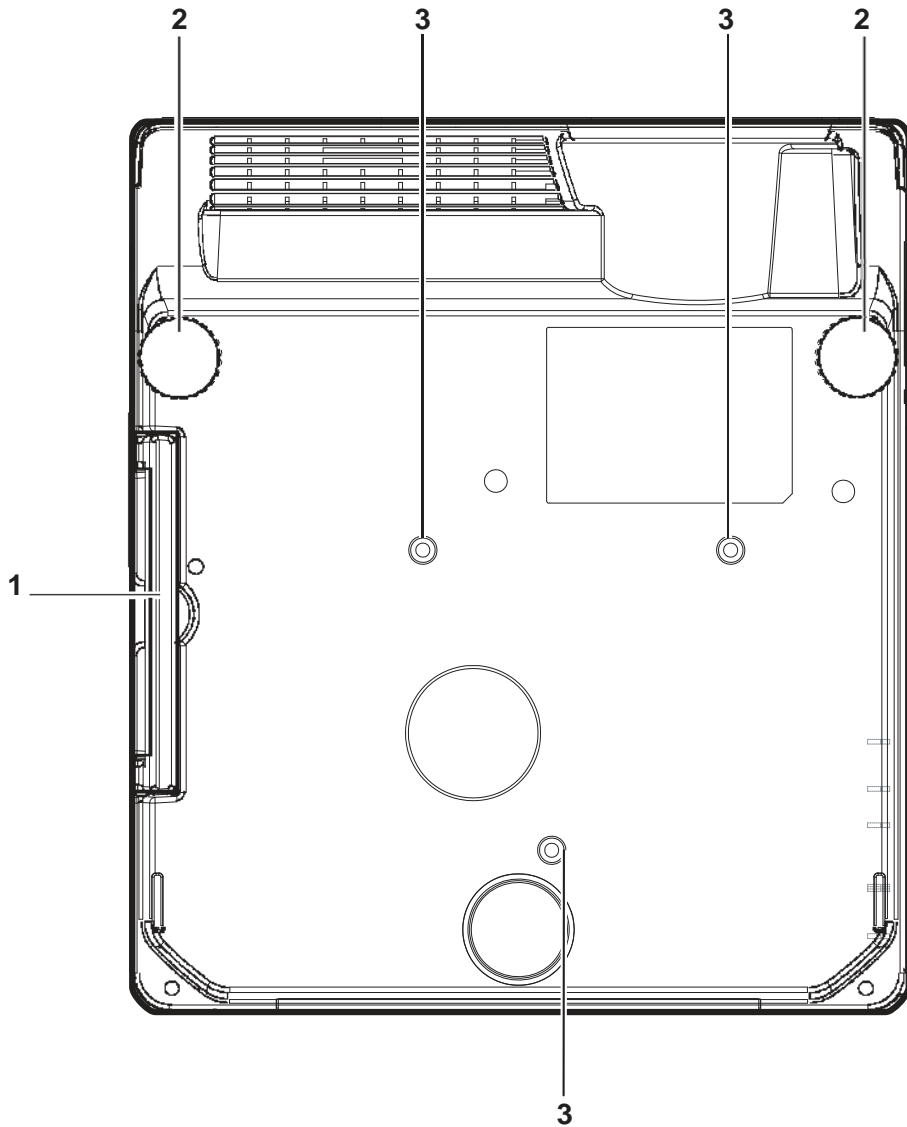

ITEM	LABEL	DESCRIPTION	SEE PAGE:
1.	Carry handle	Unfold to carry projector	—
2.	Height adjusters	Adjust level of projector	16
3.	Ceiling support holes	Contact your dealer for information on mounting the projector on a ceiling.	

Caution:

For ceiling installations, use approved mounting hardware and M4 screws with a maximum screw depth of 6 mm (1/4 inch). To allow for proper ventilation, keep a distance of 50 cm (20 inches) from walls and ceiling. For permanent installations, follow local codes. See “Ceiling Installation” on page 42 for more information.

Remote Control Parts

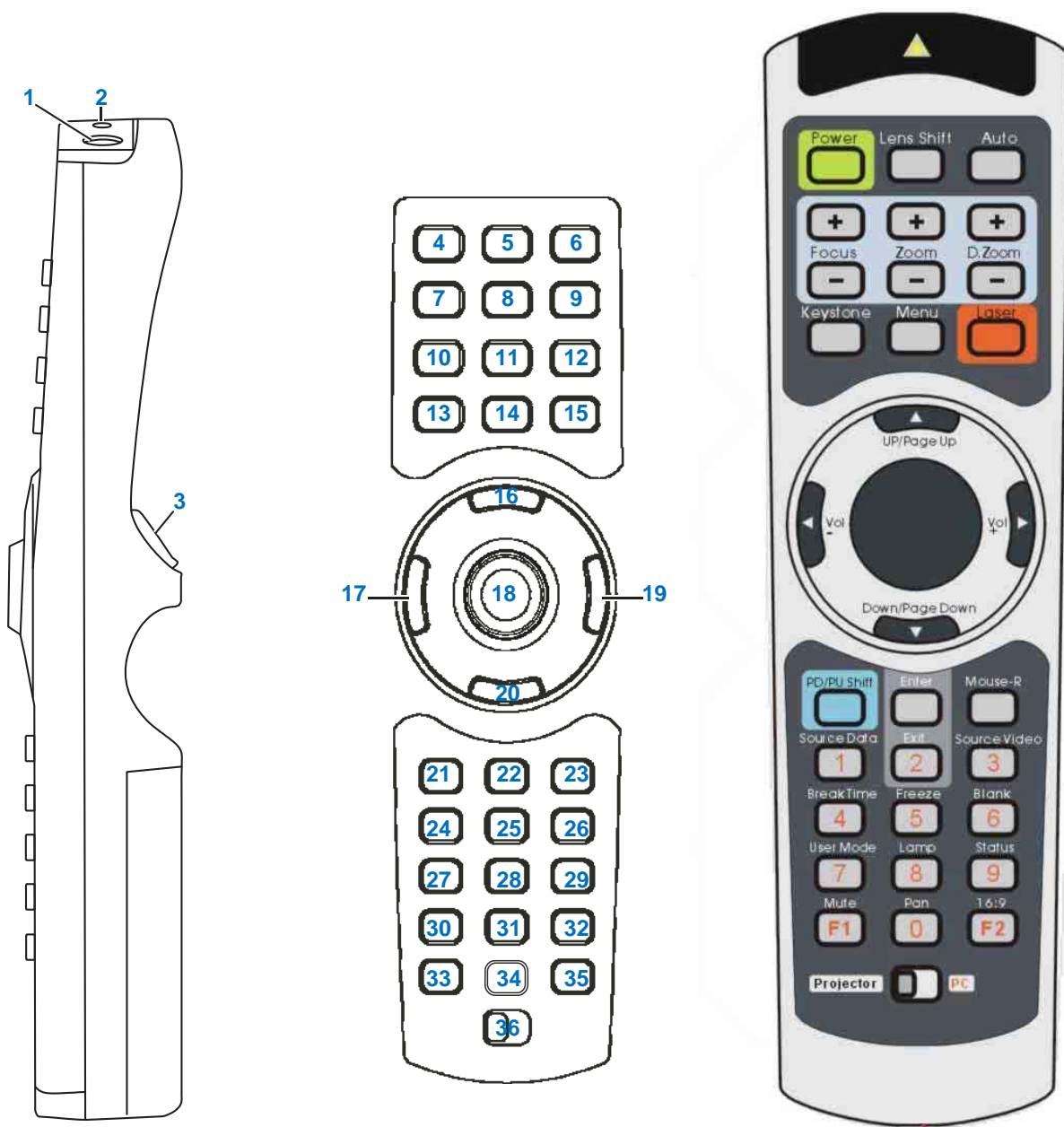

Important:

1. Avoid using the projector with bright fluorescent lighting turned on. Certain high-frequency fluorescent lights can disrupt remote control operation.

2. Be sure nothing obstructs the path between the remote control and the projector. If the path between remote control and the projector is obstructed, you can bounce the signal off certain reflective surfaces such as projector screens.

3. The buttons and keys on the projector have the same functions as the corresponding buttons on the remote control. This user's manual describes the functions based on the remote control.

ITEM	LABEL	DESCRIPTION
1.	IR Signal	Sends IR signal to projector
2.	Wired Remote	Connect a cable to the projector for wired remote control
3.	Mouse-L	Left-mouse button when connected to a PC
4.	Power	Turn the projector on and off
5.	Lens Shift	Shift the lens vertically up or down
6.	Auto	Automatically synchronize video settings
7.	Focus+	Press to increase the motorized focus
8.	Zoom+	Press to increase the motorized zoom
9.	D.Zoom+	Press to increase the digital zoom
10.	Focus-	Press to decrease the motorized focus
11.	Zoom-	Press to decrease the motorized zoom
12.	D.Zoom-	Press to decrease the digital zoom
13.	Keystone	Press to open the keystone menu
14.	Menu	Open and close the On Screen Display (OSD)
15.	Laser	Press to use the laser pointer
16.	Up/Page Up	OSD selection (up), USB up arrow key when button 21 LED is on
17.	Vol-	Decrease volume, select menu sub item and decrease values
18.	Mouse pad	Move the mouse pointer when connected to a PC
19.	Vol+	Increase volume, select menu sub item and increase values
20.	Down/Page Down	OSD selection (down), USB down arrow key when button 21 LED is on
21.	PD/PU Shift	Enable or disable USB page up and page down function
22.	Enter	Press to confirm settings in OSD
23.	Mouse-R	Right-mouse button when connected to a PC
24.	SourceData	Press repeatedly to select data source: RGB, DVI, RGBHV, Wireless
25.	Exit	Exit OSD (when in main menu), go to previous menu (when in child menu)
26.	SourceVideo	Press repeatedly to select video source: S-Video, Component, HDMI

ITEM	LABEL	DESCRIPTION
27.	BreakTime	Put the projector in standby for the time specified in the Service Menu. See page 35.
28.	Freeze	Freeze the onscreen image
29.	Blank	Blank the display
30.	UserMode	Select user picture mode
31.	Lamp	Open lamp settings menu
32.	Status	Open the service menu
33.	Mute	Mute the audio
34.	Pan	Digital pan
35.	16:9	Open the aspect ratio menu
36.	Projector PC	Swap IR function for PC or Projector

Note:

The remote control can only interface with a computer when connected to the computer through a USB cable connection. The computer cable connects a computer to the projector for display purposes only.

Remote Control Operating Range

The remote control uses infrared transmission to control the projector. It is not necessary to point the remote directly at the projector. Provided you are not holding the remote perpendicular to the sides or the rear of the projector, the remote will function well within a radius of about 10 meters (33 feet) and 30 degrees above or below the projector level. If the projector does not respond to the remote control, move a little closer.

Projector and Remote Control Buttons

The projector can be operated using the remote control or the buttons on the top of the projector. All operations can be carried out with the remote control; however the buttons on the projector are limited in use.

SETUP AND OPERATION

Inserting the Remote Control Batteries

1. Remove the battery compartment cover by sliding the cover in the direction of the arrow.

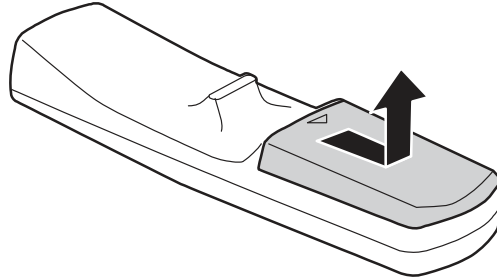

2. Insert the supplied batteries taking note of the polarity (+/-) as shown here.

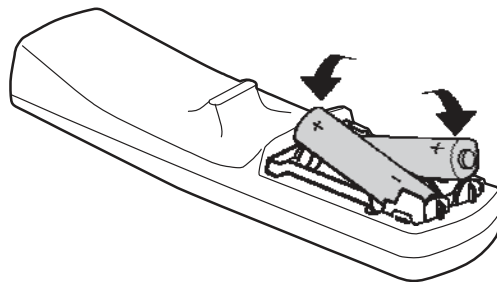

3. Replace the cover.

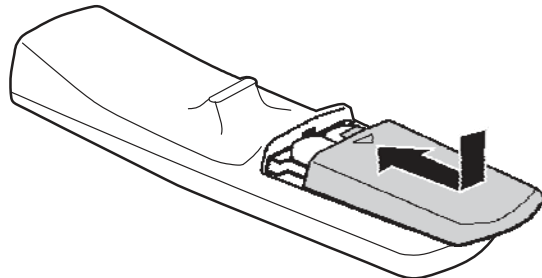

Caution:

1. Only use AAA alkaline batteries.
2. Dispose of used batteries according to local ordinance regulations.
3. Remove the batteries when not using the projector for prolonged periods.

Connecting Input Devices

A PC or notebook computer as well as video devices can be connected to the projector at the same time. Video devices include DVD, VCD, and VHS players, as well as movie camcorders and digital still cameras. Check the user manual of the connecting device to confirm it has the appropriate output connector.

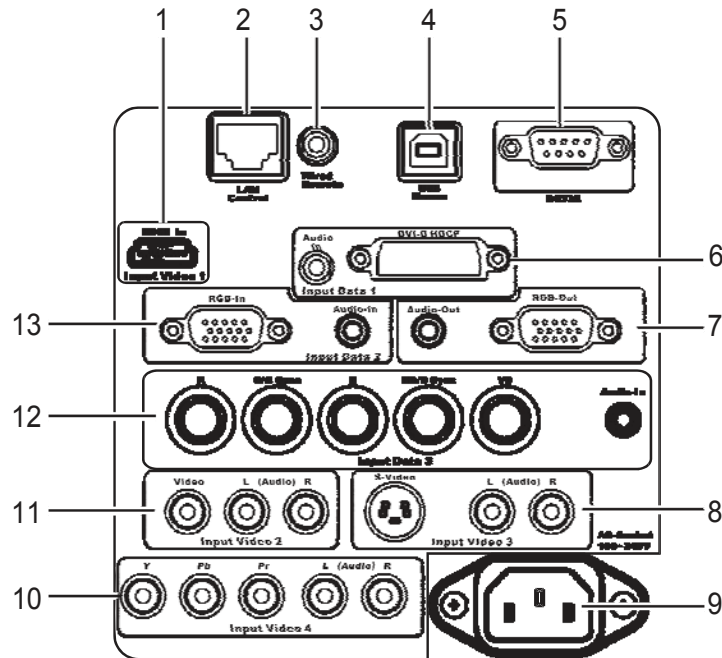

ITEM	LABEL	DESCRIPTION
1.	Input Video 1	Connect an HDMI cable from an HDTV
2.	LAN Control	Connect a LAN cable for controlling projector through a PC
3.	Wired Remote	Connect a wired remote control
4.	USB Mouse	Connect the USB cable from a computer
5.	RS232	This is a service port for firmware upgrades.
6.	Input Data 1	Connect a DVI computer cable from a computer
7.	Audio-Out	Connect an audio cable to external speakers
	RGB-Out	Connect an RGB cable to an external monitor
8.	Input Video 3	Connect an S-video cable to the S-video connector
		Connect an RCA audio connector to L/R audio connectors
9.	Power	Connect the supplied power cord

ITEM	LABEL	DESCRIPTION
10.	Input Video 4	Connect an RCA component cable the Y/Pb/Pr connectors Connect an RCA audio connector to L/R audio connectors
11.	Input Video 2	Connect a composite video cable to the Video connector Connect an RCA audio connector to L/R audio connectors
12.	Input Data 3	Connect a 5-connector BNC (RGB + VSync + HSync) cable to a pattern generator or advanced video converter. Connect a DSUB-15-to-5BNC cable from a computer Connect an audio cable from a computer to Audio-In
13.	Input Data 2	Connect the supplied DB15-DB15 cable from a computer to RGB-In Connect an audio cable from a computer to Audio-In

The connectors you choose on the projector may depend on available corresponding connectors on the devices you are connecting to.

Connect a computer to the projector through one of the Input Data 1/2/3 connections. The order for a better signal is as follows:

1. Input Data 1 is a digital signal and offers the best connection to your computer.
2. Input Data 3 is an analog signal; use a DSUB-15-to-5BNC cable for the connection.
3. The Input Data 2 analog signal uses a standard RGB (DB15-DB15) computer cable.

Connect a video device to the projector through one of the Input Video 1/2/3/4 connections. The order for a better signal is as follows:

1. Input Video 1 is a digital signal and offers the best connection to your video device.
2. Input Video 4 uses a component cable (3 RCA connectors; red/green/blue) for the most superior analog connection.
3. Input Video 3 uses an S-video cable. S-video provides a sharper image than composite video.
4. Input Video 2 uses a composite video (yellow RCA connector) connection.

Warning:

As a safety precaution, disconnect all power to the projector and connecting devices before making connections.

Starting and Shutting down the Projector

1. Connect the power cord to the projector.
Connect the other end to a wall outlet.
The Power LED on the projector turns on.

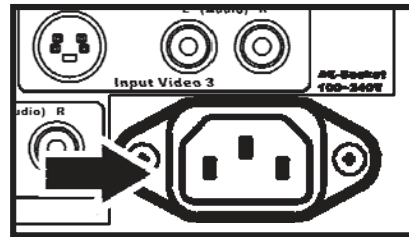

2. Turn on the connected devices.
3. Ensure the Power LED is on (not flashing) and then press the **Power** button to turn on the projector.
(If any LEDs are flashing, do not press the Power button. See “LED Error Messages” on page 45.)

The projector splash screen displays and connected devices are detected.
If the connected device is a PC, press the appropriate keys on the computer keyboard to switch the display output to the projector. (Check the user manual of the PC to determine the appropriate Fn key combination to change display output.)



4. If more than one input device is connected, press the **Source Data/Video** buttons repeatedly to switch among devices.

Press Source Data to switch among a computer connected to Computer, RGBHV, WPC (wireless), or Digital.

Press Source Video to switch among a video device connected to Video, S-Video, Component, or HDMI.



5. To turn off the projector, press the **Power** button. The projector prepares for shut-down and a “Wait a moment please...” message appears.

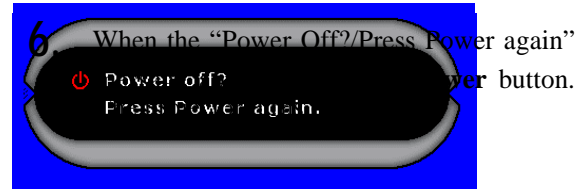

Caution:
Do not unplug the power cord until all the LEDs are on, indicating the projector has cooled down.

Adjusting the Projector Level

Take note of the following when setting up the projector:

- *The projector table or stand should be level and sturdy.*
- *Position the projector so that it is perpendicular to the screen.*
- *Be sure cables are not in the way or can not cause the projector to be knocked over.*

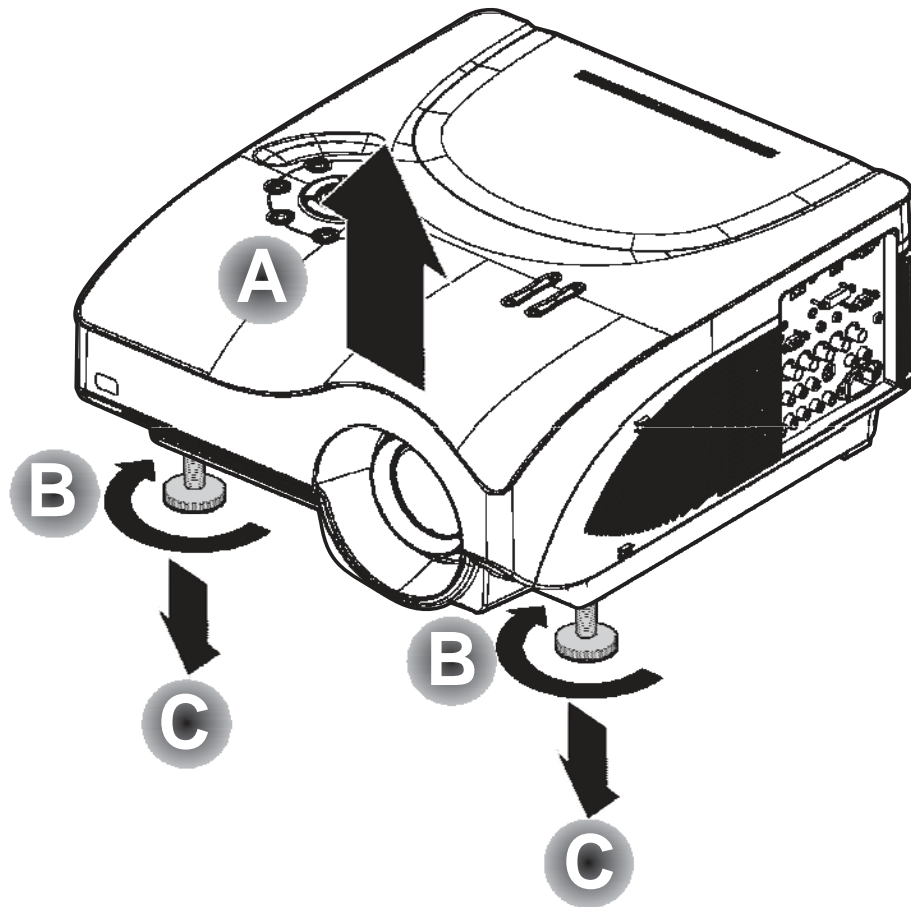

1. To raise the level of the projector, lift the projector [A] and rotate the height-adjusters [B].

The height adjusters drop down [C].

2. To lower the level of the projector, rotate the height adjusters in the opposite direction.

Adjusting the Zoom, Focus and Keystone

1. Use the **Zoom +/-** control to resize the projected image and screen size.
A display pattern appears on the screen to indicate the border of the display window; adjust until the projected image matches the display-pattern border.

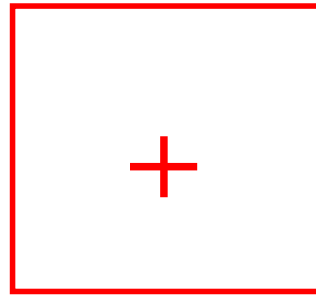

2. Use the **Focus +/-** control to sharpen the projected image.
A display pattern appears on the screen; adjust until the cross-hair is sharp.

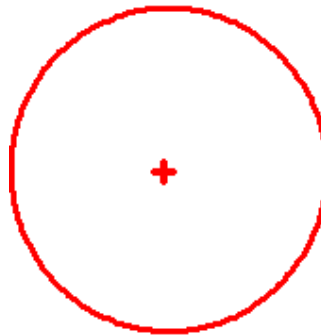

3. Use the **Keystone +/-** buttons to correct image distortion.



Adjusting the Volume

1. Press the **Volume +/-** button.
The volume control appears on the display.
2. Use the **Volume +/-** buttons to adjust the volume level.
3. Press the **Mute** button to turn off the volume.



On-Screen Display (OSD) Menu Settings

OSD Menu Controls

The projector has an OSD that lets you make image adjustments and change various settings.

Navigating the OSD

You can use the remote control cursor buttons or the buttons on the top of the projector to navigate and make changes to the OSD. The button  in the center of the projector cursor buttons corresponds to the **Enter** button on the remote control.

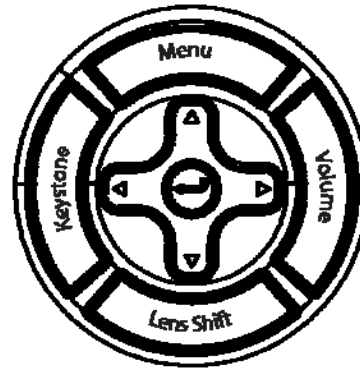
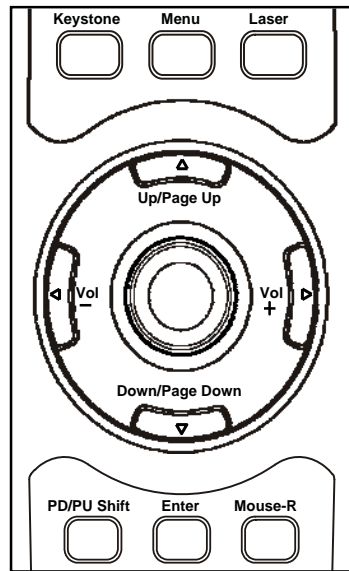

1. To open the OSD, press the **Menu** button.
2. Press the cursor◀▶ button to move through the menus.
3. Press the cursor▲▼ button to move up and down in a menu.
4. Press◀▶ to change values for settings.
5. Press **Menu** to close the OSD or leave a submenu.

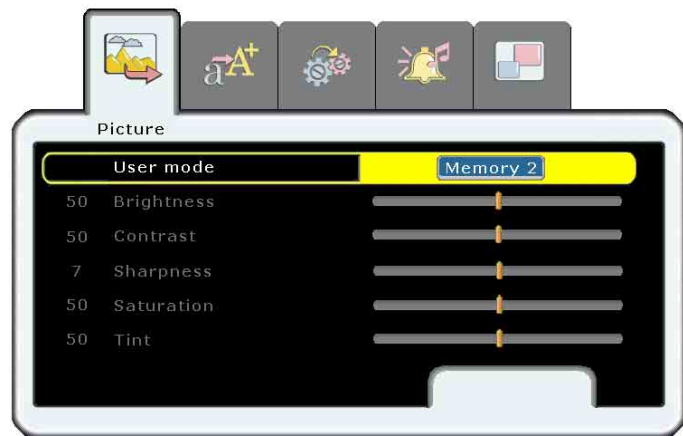

Setting the OSD Language

You may want to reference the OSD on your projector while reading this section. Set the OSD language to your preference before continuing. (The default language is English.)

1. Press the **Menu** button. The **Picture** menu appears.



2. Press the cursor◀▶ button until **Setup** is highlighted.

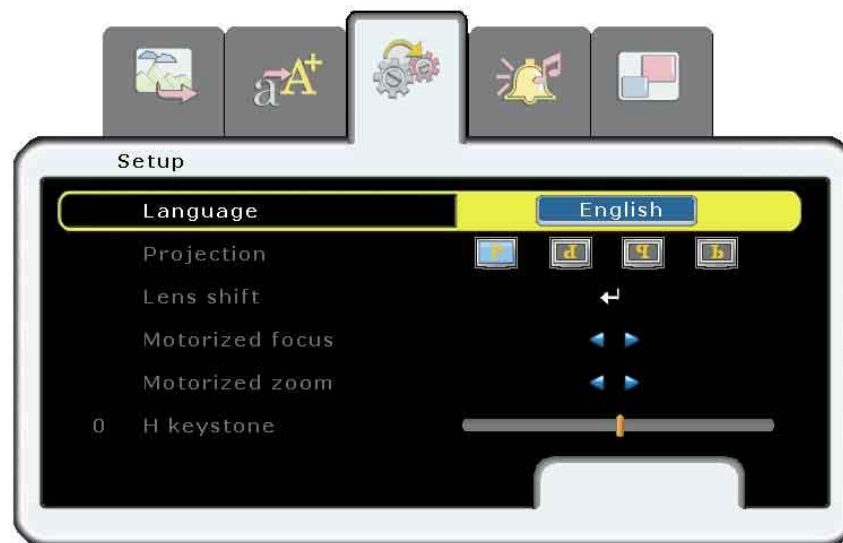















3. Press the cursor▲▼ button to highlight **Language**.
4. Press the cursor◀▶ button until the language you want is highlighted.
5. Press the **Menu** button twice to close the OSD.

Picture Menu

Press the **Menu** button to open the **OSD** menu. Press the cursor ◀▶ button to move to the **Picture** menu. Press the cursor ▲▼ button to move up and down in the **Picture** menu. Press ◀▶ to change values for settings.



ITEM	DESCRIPTION	DEFAULT																		
User mode	Press the cursor ◀▶ button to choose from three user modes: Memory 1; Memory 2; and Memory 3. Any settings you change in the Picture menu are saved in Memory that you have selected.	—																		
Brightness	Press the cursor ◀▶ button to adjust the brightness. (Range: 0 – 100)	50																		
Contrast	Press the cursor ◀▶ button to adjust the contrast. (Range: 0 – 100)	50																		
Sharpness	Press the cursor ◀▶ button to adjust the display sharpness (Range: 0 – 100)	50																		
Saturation	Press the cursor ◀▶ button to adjust the video saturation. (Range: 0 – 100)	50																		
Tint	Press the cursor ◀▶ button to adjust the video tint/hue. (Range: 0 – 100)	50																		
Gamma	Press the cursor ◀▶ button to adjust the gamma correction of the display. <table border="0" style="width: 100%;"> <thead> <tr> <th style="text-align: left;">Input</th> <th style="text-align: left;">Gamma</th> <th style="text-align: left;">Brightness</th> </tr> </thead> <tbody> <tr> <td> PC</td> <td>2.2</td> <td>High</td> </tr> <tr> <td> MAC</td> <td>1.8</td> <td>High</td> </tr> <tr> <td> Video</td> <td>2.4</td> <td>Low</td> </tr> <tr> <td> Chart</td> <td>2.2</td> <td>Low</td> </tr> <tr> <td> B&W</td> <td>2.4</td> <td>High</td> </tr> </tbody> </table>	Input	Gamma	Brightness	 PC	2.2	High	 MAC	1.8	High	 Video	2.4	Low	 Chart	2.2	Low	 B&W	2.4	High	<p>PC: Computer, 5BC, Digital</p> <p>Video: Video, S-Video, Component, HDMI</p>
Input	Gamma	Brightness																		
 PC	2.2	High																		
 MAC	1.8	High																		
 Video	2.4	Low																		
 Chart	2.2	Low																		
 B&W	2.4	High																		

ITEM	DESCRIPTION	DEFAULT
Color Temp	Press the cursor ◀▶ button to adjust the color temperature. Range: High brightness mode 6400K, CT x = 0.3; CT y = 0.33 Preset mode From 5000K to 12000K (increments of 100K) Custom mode Will update when hardware is available.	High-brightness
Color Space	Press the cursor ◀▶ button to adjust the color space. (Range: RGB – YCbCr – YpbPr – SMPTE240M – Blue only)	RGB: Computer, 5BNC, DVI YCbCr: DVI
Video format	Press the cursor ◀▶ button to adjust the video format. (Range: Auto – NTSC 50Hz 3.58MHz – NTSC 60Hz 3.58MHz – NTSC 60Hz 4.43MHz – PAL 50Hz 4.43MHz – PAL 60Hz 3.58MHz – PAL 50Hz 3.58MHz – PAL 60Hz 4.43MHz – SECAM50Hz 4.43MHz)	Auto
Color balance Red/Green/ Blue	Press the cursor ◀▶ button to adjust the red/green/blue color balance. (Range: 0 – 100)	50
Fleshtone	Skin colors can become corrupted during the broadcast process. Use this setting to correct skin color as desired. Press the cursor ◀▶ button to adjust the Fleshtone. (Range: 0 – 100)	50
Film mode	Film is a digital video recording with the original recording encoded at 24 fps (frame per second, i.e., full-motion video). The projector can convert film source to progressive video at 60 fps with NTSC and PAL60Hz or at 50 fps with PAL50Hz and SECAM. The result is high-definition play back. Press the cursor ◀▶ button to enable or disable Film mode.	On
3D Comb Filter	This technique provides near perfect Y/C separation for still images. Press the cursor ◀▶ button to enable or disable 3D Comb Filter.	On
White peaking	White Peaking increases the output in the brightest whites without changing the blacks and dark grays. It crushes the whites slightly, but it does not appear to clip them or seriously obscure white detail. If you prefer a stronger image, adjust toward the maximum setting. For a smoother, more natural image, adjust toward the minimum setting. Press the cursor ◀▶ button to adjust the White Peaking. (Range: 0 – 10)	10
Reset	Resets all Picture settings to default values	—

P icture Menu Functions Available for Connected Source

Function	Computer	RGBHV	WPC	Digital	Component	Composite	S-Video	HDMI
Brightness	X	X	X	X	X	X	X	X
Contrast	X	X	X	X	X	X	X	X
Sharpness	X	X	X	X	X	X	X	X
Saturation	X	X		X	X	X	X	X
Tint	X	X		X	X	X	X	X
Gamma	X	X	X	X	X	X	X	X
Color Temp	X	X	X	X	X	X	X	X
CT x value	X	X	X	X	X	X	X	X
CT y value	X	X	X	X	X	X	X	X
Color space	X	X		X	X			
Video format						X	X	
Color Balance	X	X	X	X	X	X	X	X
Red/Green/Blue								
Flesh tone correction					X	X	X	X
Film mode	X	X	X	X	X	X	X	X
3D Comb Filter						X		
White Peaking	X	X	X	X	X	X	X	X
Reset	X	X	X	X	X	X	X	X

x = available to video source

Advance Menu

Press the **Menu** button to open the **OSD** menu. Press the cursor ◀▶ button to move to the **Advance** menu. Press the cursor ▲▼ button to move up and down in the **Advance** menu. Press ◀▶ to change values for settings.

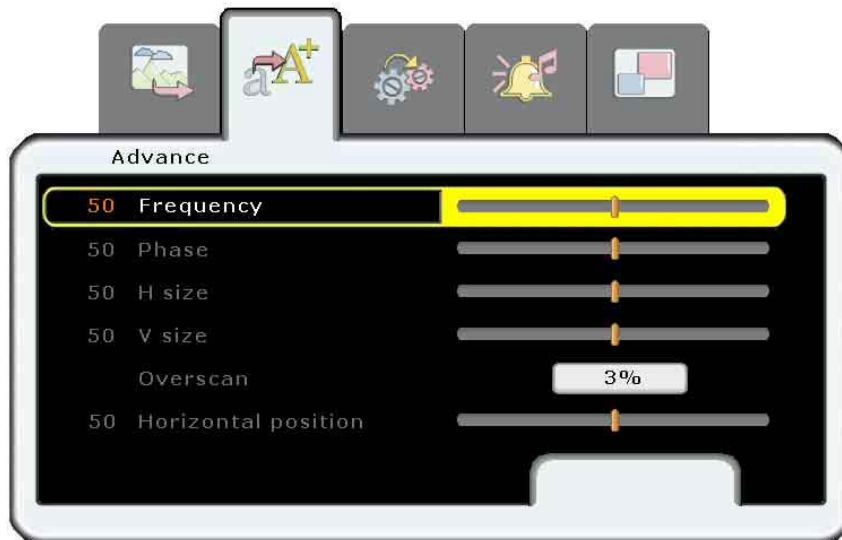

ITEM	DESCRIPTION	DEFAULT
Frequency	Press the cursor ◀▶ button to adjust the A/D sampling number. (Range: 0° - 100°)	Auto detected
Phase	Press the cursor ◀▶ button to adjust the A/D sampling phase. (Range: 0° - 100°)	Auto detected
H size	Press the cursor ◀▶ button to adjust the size of the display horizontally. (Range: 0 – 100)	50
V size	Press the cursor ◀▶ button to adjust the size of the display vertically. (Range: 0 – 100)	50
Overscan	Use overscan to trim an unwanted blank border from the onscreen image. Press the cursor ◀▶ button to adjust video overscan. (Range: 0% – 10%)	3%: composite, S-video, component 0%: 5BNC, DVI, HDMI, Wireless
Horizontal Position	Press the cursor ◀▶ button to move the image left or right. (Range: 0 – 100)	50
Vertical Position	Press the cursor ◀▶ button to move the image up or down. (Range: 0 – 100)	50

ITEM	DESCRIPTION	DEFAULT
Aspect Ratio	Press the cursor ◀▶ button to adjust the video aspect ratio. 1:1 – Native size, no scaling 4:3 – Standard TV format 16:9 – High Definition TV (HDTV) format 2.35:1 – Anamorphic format (Anamorphic format maximizes the resolution on wide screen TVs as well as standard TVs that support the anamorphic mode.)	4:3
Blank color	Press the cursor ◀▶ button to select a background color for the blank screen instead of the default logo.	Logo
Auto sync	Press Enter to auto tune the timing phase, frequency, and horizontal/vertical position.	—
Auto search	Press the cursor ◀▶ button to enable or disable auto search for connected devices. When disabled, you have to manually select the source.	On
Freeze frame	Freeze frame allows you to pause onscreen video. Press the cursor ◀▶ button to enable or disable Freeze frame.	On
Video AGC	Press the cursor ◀▶ button to enable or disable Video AGC. When enabled, the automatic gain control for the video source is auto adjusted to match the video standard.	On
Black level	Press the cursor ◀▶ button to enable or disable the 7.5 setup for NTSC. (Range: On = 7.5 IRE; Off = 0 IRE) NTSC uses 7.5 IRE except for Japan which uses 0 IRE. Set Black level to Off for use in Japan only.	On
Digital zoom	Press the cursor ◀▶ button to adjust the digital zoom. (Range: 0 – 23) Note: Digital zoom is not available when you are using PIP.	0
Reset	Resets all items in the Advance menu to default values	—

A dvance Menu Functions Available for Connected Source

Function	Computer	RGBHV	WPC	Digital	Component	Composite	S-Video	HDMI
Phase	x	x	x		x			
Frequency	x	x	x		x			
H position	x	x	x		x	x	x	
V position	x	x	x		x	x	x	
Aspect Ratio	x	x	x	x	x	x	x	x
H size	x	x	x	x	x	x	x	x
V size	x	x	x	x	x	x	x	x

DLP Projector—User's Manual

Function	Computer	RGBHV	WPC	Digital	Component	Composite	S-Video	HDMI
Overscan		X		X	X	X	X	X
Auto sync	X	X	X					
Auto search	X	X	X	X	X	X	X	X
Freeze frame	X	X	X	X	X	X	X	X
Blank color	X	X	X	X	X	X	X	X
Video AGC						X	X	
Black level						X	X	
Digital zoom	X	X	X	X	X	X	X	X
Reset	X	X	X	X	X	X	X	X

x = available to video source

Setup Menu

Press the **Menu** button to open the **Main** menu. Press the cursor ◀▶ button to move to the **Setup** menu. Press the cursor ▲▼ button to move up and down in the **Setup** menu. Press ◀▶ to change values for settings.

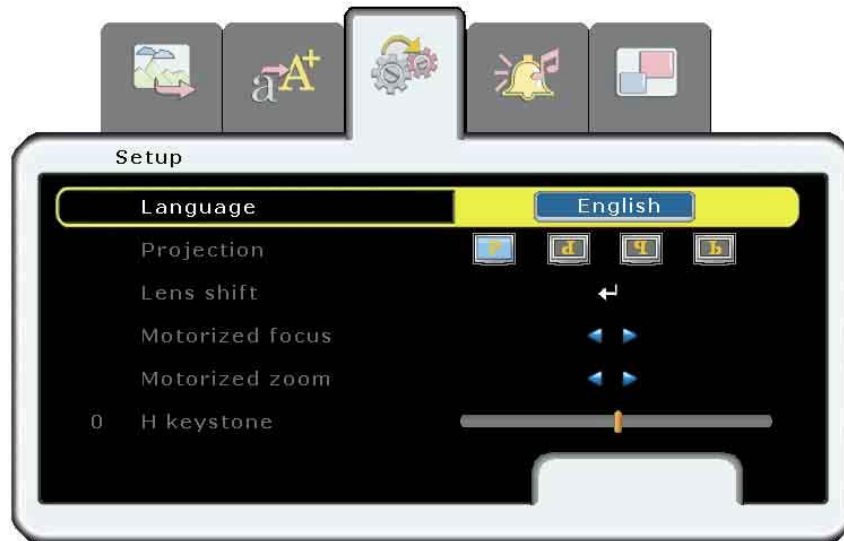

ITEM	DESCRIPTION	DEFAULT
Language	Press the cursor ◀▶ button to choose from the following languages: English, French, German, Italian, Spanish, Swedish, Chinese Simplified, Chinese Traditional, Japanese, Korean, Portuguese, and Russian.	English
Projection	Press the cursor ◀▶ button to choose from four projection methods: <div style="display: flex; flex-direction: column; align-items: center; gap: 10px;"> <div style="display: flex; align-items: center; gap: 10px;"> P Desktop mount, front of screen </div> <div style="display: flex; align-items: center; gap: 10px;"> Q Desktop mount, rear of screen </div> <div style="display: flex; align-items: center; gap: 10px;"> d Ceiling mount, front of screen </div> <div style="display: flex; align-items: center; gap: 10px;"> B Ceiling mount, rear of screen </div> </div>	Desktop front P
Lens shift	Press Enter to activate lens shift. The following screen appears. <div style="text-align: center; border: 2px solid green; padding: 5px; margin: 10px 0;"> </div> Press the up/down/left/right cursor buttons to shift the lens vertically and horizontally.	—
Motorized focus	Press the cursor ◀▶ button to adjust the motorized focus.	—

ITEM	DESCRIPTION	DEFAULT
Motorized zoom	Press the cursor ◀▶ button to adjust the motorized zoom.	—
H keystone	Press the cursor ◀▶ button to correct horizontal distortion of the projected image. (Range: -100 – +100)	0
V keystone	Press the cursor ◀▶ button to correct vertical distortion of the projected image. (Range: -100 – +100)	0
Lamp control—Press the cursor ▶ button to display the hidden Lamp control submenu.		
Mode	Press the cursor ◀▶ button to toggle between Dual lamp and Single lamp. Dual lamp uses both lamps in the projector. Single lamp uses the lamp which has been used the least.	Dual lamp
Lamp 1	Press the cursor ◀▶ button to toggle between ECO mode and Normal mode. Eco mode uses less power and extends lamp life, but decreases lamp brightness.	Normal
Lamp 2	Press the cursor ◀▶ button to toggle between ECO mode and Normal mode. Eco mode uses less power and extends lamp life, but decreases lamp brightness.	Normal
OSD settings—Press the cursor ▶ button to display the hidden OSD settings submenu.		
Position	Press the cursor ◀▶ button to position the OSD on screen. (Range: Left – Right – Center – Down – Up)	Center
Transparency	Press the cursor ◀▶ button to set menu screen translucency. (Range: 0 – 100)	50
Timeout(sec)	Press the cursor ◀▶ button to determine the timeout delay of the OSD. (Range: Always on – 100 seconds)	20
Message	Press the cursor ◀▶ button to show or hide the OSD information screen in the bottom-right corner of the screen.	On
Menu type	Press the cursor ◀▶ button to toggle between Expert mode and Normal mode. In Expert mode all settings are available in the OSD.	Expert
Logo settings—Press the cursor ▶ button to display the hidden Logo settings submenu.		
Logo display	Press ◀▶ to enable or disable if the logo displays when the projector starts, and when no source is detected. (Range: On—Off)	On
Logo select	Press ◀▶ to select a different image for the logo display. To use this function you must capture an image with the following “Logo capture” function.	Default (preset image)

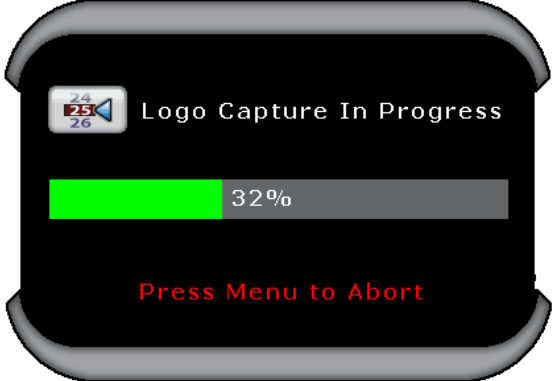
ITEM	DESCRIPTION	DEFAULT
Logo capture	<p>Press Enter to capture the current display image as the logo. The following screen appears:</p>  <p>Logo capture is only available for Computer, RGBHV, and DVI input.</p>	—
Fan control	<p>Press the cursor ◀▶ button to toggle between Normal and High altitude fan speeds.</p> <p>Set Fan control to High in altitudes over 3,000 meters (10,000 feet).</p>	Normal
Reset	Resets all items in the Setup menu to default values	

Setup Menu Functions Available for Connected Source

Function	Computer	RGBHV	WPC	Digital	Component	Composite	S-Video	HDMI
Language	x	x	x	x	x	x	x	x
Projection	x	x	x	x	x	x	x	x
Lens shift	x	x	x	x	x	x	x	x
Motorized focus	x	x	x	x	x	x	x	x
Motorized zoom	x	x	x	x	x	x	x	x
H keystone	x	x	x	x	x	x	x	x
V keystone	x	x	x	x	x	x	x	x
Lamp mode	x	x	x	x	x	x	x	x
Lamp mode (Lamp1)	x	x	x	x	x	x	x	x
Lamp mode (Lamp2)	x	x	x	x	x	x	x	x
OSD position	x	x	x	x	x	x	x	x
OSD translucency	x	x	x	x	x	x	x	x
OSD timeout	x	x	x	x	x	x	x	x
Menu type	x	x	x	x	x	x	x	x

DLP Projector—User's Manual

Function	Computer	RGBHV	WPC	Digital	Component	Composite	S-Video	HDMI
Logo display	x	x	x	x	x	x	x	x
Logo select	x	x	x	x	x	x	x	x
Logo capture	x	x	x	x	x	x	x	x
Fan control	x	x	x	x	x	x	x	x
Reset	x	x	x	x	x	x	x	x

x = available to video source

Audio Menu

Press the **Menu** button to open the **Main** menu. Press the cursor ◀▶ button to move to the **Audio** menu. Press the cursor ▲▼ button to move up and down in the **Audio** menu. Press ◀▶ to change values for settings.



ITEM	DESCRIPTION	DEFAULT
Volume	Press the cursor ◀▶ button to adjust the audio volume level. (Range: 0 - 100)	50
Treble	Press the cursor ◀▶ button to adjust the audio treble level. (Range: 0 - 100)	50
Bass	Press the cursor ◀▶ button to adjust the audio bass level. (Range: 0 - 100)	50
Balance	Press the cursor ◀▶ button to adjust the audio volume level. (Range: -50 - +50)	0
Mute	Press the cursor ◀▶ button to enable or disable mute.	Off
Reset	Resets all items in the Audio menu to default values	—

Audio Menu Functions Available for Connected Source

Function	Computer	RGBHV	WPC	Digital	Component	Composite	S-Video	HDMI
Volume	x	x	x	x	x	x	x	x
Treble	x	x	x	x	x	x	x	x
Bass	x	x	x	x	x	x	x	x
Balance	x	x	x	x	x	x	x	x
Mute	x	x	x	x	x	x	x	x
Reset	x	x	x	x	x	x	x	x

x = available to video source

Window Menu

PIP (Picture In Picture) mode allows you to view a small video window in a full-screen video display. For example, while displaying output from your PC you could have a small window displaying your video source. You can also have the active windows display side-by-side, which is sometimes referred to as POP.

Press the **Menu** button to open the **Main** menu. Press the cursor ◀▶ button to move to the **Window** menu. Press the cursor ▲▼ button to move up and down in the **Window** menu. Press ◀▶ to change values for settings.

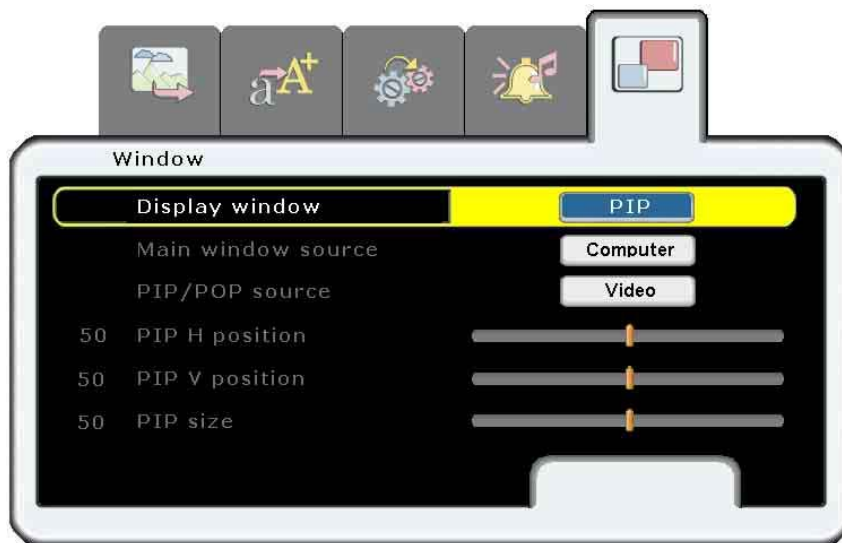

ITEM	DESCRIPTION	DEFAULT
Display window	Press the cursor ◀▶ button to choose from three settings: Single (one window); PIP (Picture In Picture); Side by side (POP, two equal-sized windows beside each other) Note: When Single is selected only the Main window source item is available.	Single
Main window source	Press the cursor ◀▶ button to choose the input device for the main window.	Last selected
PIP/POP source	Press the cursor ◀▶ button to choose the input device for the second window.	Last selected
PIP H position	Press the cursor ◀▶ button to adjust the PIP window horizontally. (Range: 0 – 100) Note: This item is not available for Side by side mode.	0
PIP V position	Press the cursor ◀▶ button to adjust the PIP window vertically. (Range: 0 – 100) Note: This item is not available for Side by side mode.	0

ITEM	DESCRIPTION	DEFAULT
PIP size	Press the cursor ◀▶ button to adjust the size of the PIP window. (Range: 20 – 100, depending on the timing resolution of the main window) Note: This item is not available for Side by side mode.	20
Source	Press Enter to swap the current sources for the active windows.	—
PIP alpha blend	PIP alpha blend allows you to adjust translucency between the main window and the PIP window. Press the cursor ◀▶ button to adjust the PIP alpha blend. (Range: 0 – 100)	0
Reset	Resets all items in the Window menu to default values	—

ColorMgr Menu

Press the **Menu** button to open the **Main** menu. Press the cursor ◀▶ button to move to the **ColorMgr** menu. Press the cursor ▲▼ button to move up and down in the **ColorMgr** menu. Press ◀▶ to change values for settings.

Note:

This menu is not available when ColorTemp is set to High-brightness.



ITEM	DESCRIPTION	DEFAULT
Color select	Press the cursor ◀▶ button to select a color. Use the Lightness , Chroma , and Hue settings to adjust each color as desired. (Range: red, green, blue, cyan, magenta, yellow)	
Lightness	Press the cursor ◀▶ button to adjust the lightness of the selected color. (Range: 0 – 100)	50
Chroma	Press the cursor ◀▶ button to adjust the saturation of the selected color. (Range: 0 – 100)	100
Hue	Press the cursor ◀▶ button to adjust the tint of the selected color. (Range: 0 – 360)	180
Reset	Resets all items in the ColorMgr menu to default values	—

Service Menu

Press the **Menu** button to open the **Main** menu. Press the cursor ◀▶ button to move to the **Service** menu. Press the cursor ▲▼ button to move up and down in the **Service** menu. Press ◀▶ to change values for settings.

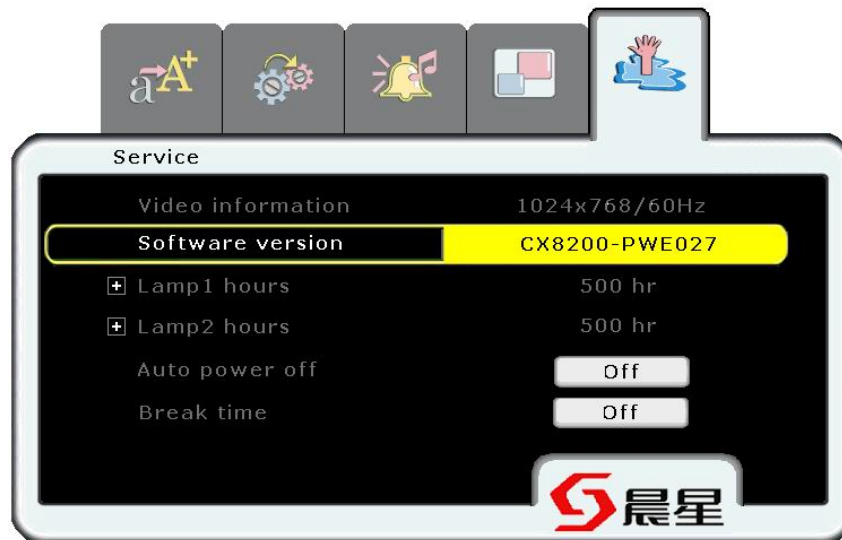

ITEM	DESCRIPTION	DEFAULT
Video information	Displays the resolution and refresh rate for RGB/DVI mode. Displays the color standard for video mode.	These items are display only.
Serial number	Displays the serial number.	
Software version	Displays information about the firmware version.	
Lamp1 hours	Press the cursor ▶ button to see the number of hours Lamp 1 has been in use for ECO and Normal mode.	
Lamp2 hours	Press the cursor ▶ button to see the number of hours Lamp 2 has been in use for ECO and Normal mode.	
Auto power off	Press ◀▶ to enable or disable automatic shut-down of lamp after the specified time of inactivity. (Range: Off; 5 – 60 minutes)	5 minutes
Break time	Set the length of time the projector goes into standby when the Break time button on the remote control is pressed. While in standby, the break time displays on the screen. Press the cursor ◀▶ button to adjust the Break time. (Range: 0 – 180 minutes)	0
Serial control—Press the cursor ▶ button to display the hidden Serial control submenu.		
Baud rate	Press the cursor ◀▶ button to choose a baud rate for the RS232 connector.	9600bps

ITEM	DESCRIPTION	DEFAULT
Parity	Press the cursor ◀▶ button to choose the parity setting for the RS232 connector.	None
Password—Press the cursor ▶ button to display the hidden Password submenu.		
Password enable	Press the cursor ◀▶ button to enable or disable a user password. When you enable the password, it is automatically set to the default [000000]. Use the remote control to enter a new alphanumeric password. When enabled, settings in the Setup and Service menus cannot be changed.	Disabled
Set Password	To set a password, press the cursor ◀▶ button to select a field; press the cursor ▲▼ button to change values. Select OK and press Enter to confirm.	—
Change Password	To change the password, press the cursor ◀▶ button to select a field; press the cursor ▲▼ button to change values. Select OK and press Enter to confirm.	—
Lamp hours reset	After replacing the lamp, this item should be reset. Refer to “Retting the Lamp” on page 40.	—
Reset	Resets all items in the Service menu to default values	—

Network Menu

Press the **Menu** button to open the **Main** menu. Press the cursor ◀▶ button to move to the **Network** menu. Press the cursor ▲▼ button to move up and down in the **Network** menu. Press ◀▶ to change values for settings.

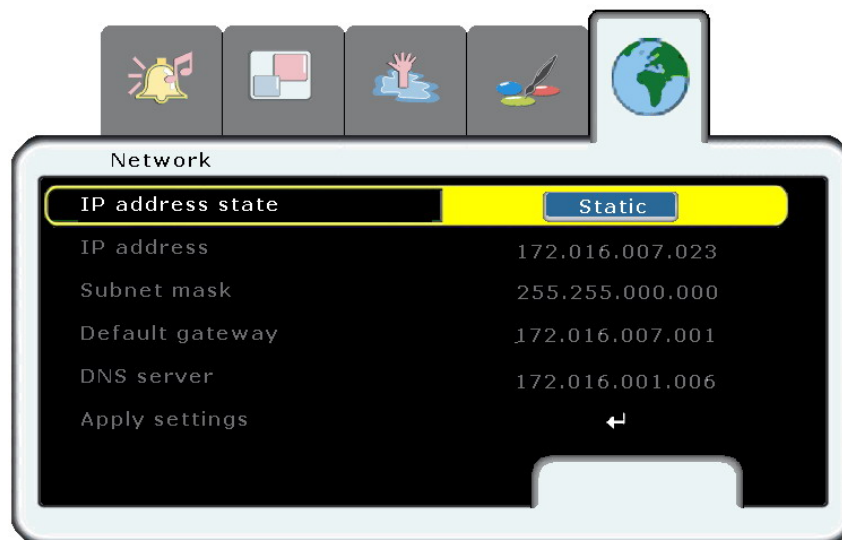

ITEM	DESCRIPTION	DEFAULT
IP address state	Press the cursor ◀▶ button to toggle between DHCP and Static. Choose DHCP (Dynamic Host Configuration Protocol) if your router automatically assigns temporary IP addresses. If you choose Static you must manually assign an IP address, Subnet mask, Default gateway, and DNS server.	DHCP
IP address	Press the cursor ◀▶ button to select a field; press the cursor ▲▼ button to change values.	—
Subnet mask	Press the cursor ◀▶ button to select a field; press the cursor ▲▼ button to change values.	—
Default gateway	Press the cursor ◀▶ button to select a field; press the cursor ▲▼ button to change values.	—
DNS server	Press the cursor ◀▶ button to select a field; press the cursor ▲▼ button to change values.	—
Apply settings	Press Enter to apply the settings.	—

Maintenance AND Security

Replacing the Projection Lamp

The projection lamp should be replaced when it burns out. It should only be replaced with a certified replacement part, which you can order from your local dealer.

Important:

1. The lamp contains a certain amount of mercury and should be disposed of according to local ordinance regulations.

2. Avoid touching the glass surface of the new lamp: Doing so may shorten its operation life.

Warning:

Be sure to turn off and unplug the projector at least an hour before replacing the lamp. Failure to do so could result in a severe burn.

1. Loosen the captive screws on the lamp compartment cover (A).

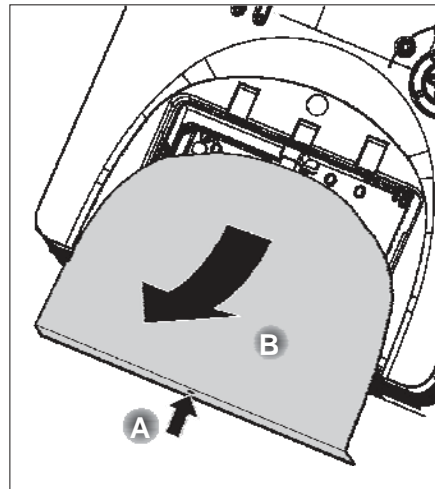

2. Remove the lamp compartment cover (B).

3. Loosen the two captive screws from the lamp module (A) you are replacing.

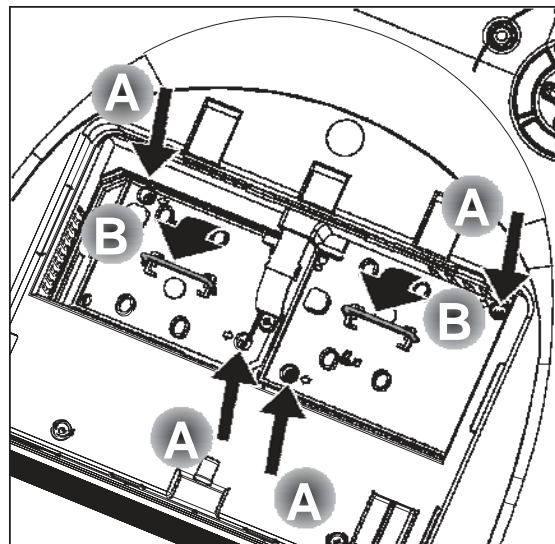

4. Lift the module handle up (B).

5. Pull firmly on the module handle to remove the lamp module.

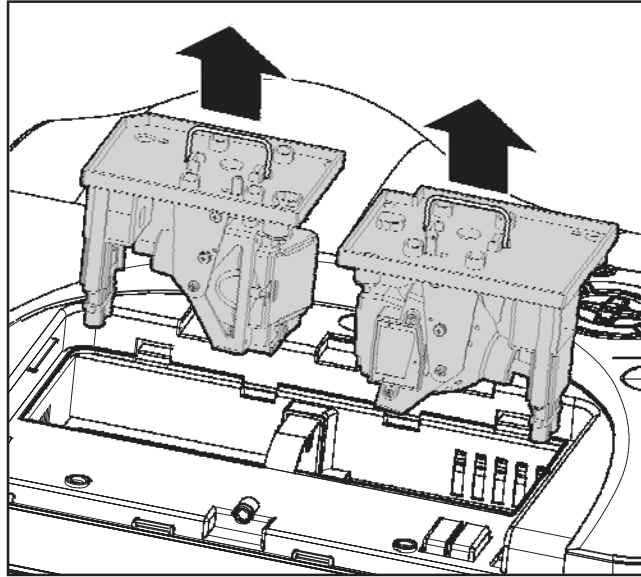

When installing the new lamp:

1. Reverse the above steps to install the new lamp module.
2. To replace the cover:
Align the cover at (A), then push down and slide the cover into place (B).
Tighten the captive screw (C).

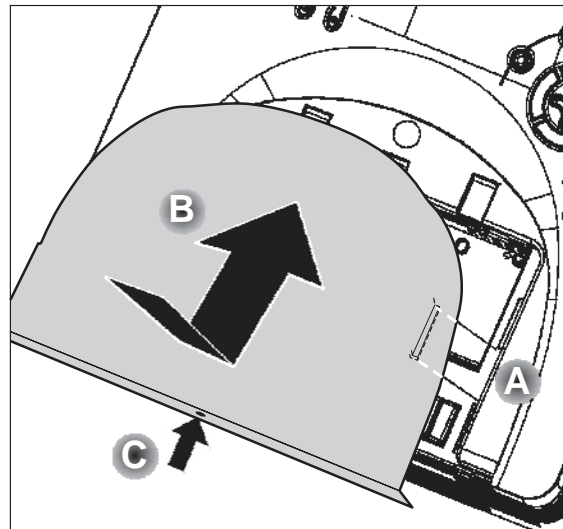

Resetting the Lamp

After replacing the lamp, you should reset the lamp hour counter to zero. Refer to the following:

1. Press the **Menu** button to open the menu.
2. Press the cursor ◀▶ button to move to the **Service** menu.
3. Press the cursor ▲▼ button to move down to **Lamp hours reset**.



4. Press the cursor ▶ or **Enter** button.

A message screen appears.

5. Press the cursor buttons in this order: ▼; ▲; ◀; ▶.

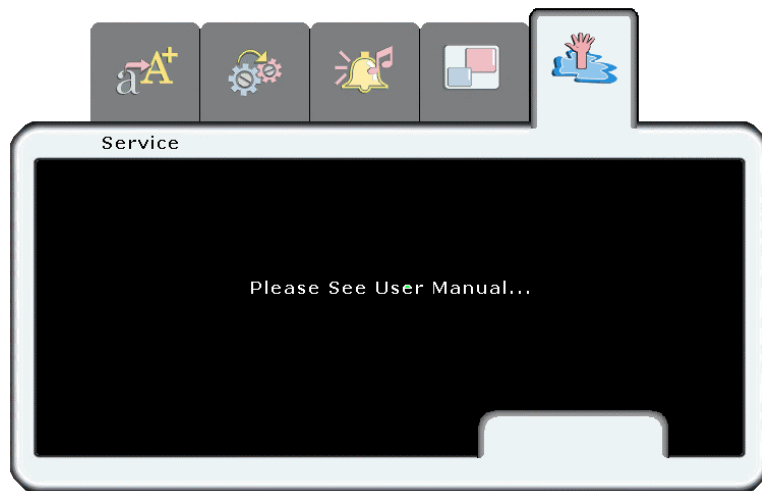

6. Press the cursor▲▼ button to select Lamp 1 or Lamp 2 and press **Enter**.
7. Press the cursor▲▼ button to select **Exit** and press **Enter**.



Cleaning the Projector

Cleaning the projector to remove dust and grime will help ensure trouble-free operation.

Warning:

- 1. Be sure to turn off and unplug the projector at least an hour before cleaning. Failure to do so could result in a severe burn.*
- 2. Use only a dampened cloth when cleaning. Do not allow water to enter the ventilation openings on the projector.*
- 3. If a little water gets into the projector interior while cleaning, leave unplugged in a well-ventilated room for several hours before using.*
- 4. If a lot of water gets into the projector interior when cleaning, have the projector serviced.*

Cleaning the Lens

You can purchase optic lens cleaner from most camera stores. Refer to the following to clean the projector lens.

1. Apply a little optic lens cleaner to a clean soft cloth. (Do not apply the cleaner directly to the lens.)
2. Lightly wipe the lens in a circular motion.

Caution:

- 1. Do not use abrasive cleaners or solvents.*
- 2. To prevent discoloration or fading, avoid getting cleaner on the projector case.*

Cleaning the Case

Refer to the following to clean the projector case.

1. Wipe off dust with a clean dampened cloth.
2. Moisten the cloth with warm water and mild detergent (such as used to wash dishes), and then wipe the case.
3. Rinse all detergent from the cloth and wipe the projector again.

Caution:

To prevent discoloration or fading of the case, do not use abrasive alcohol-based cleaners.

Using the Kensington® Lock

If you are concerned about security, attach the projector to a permanent object with the Kensington slot and a security cable.

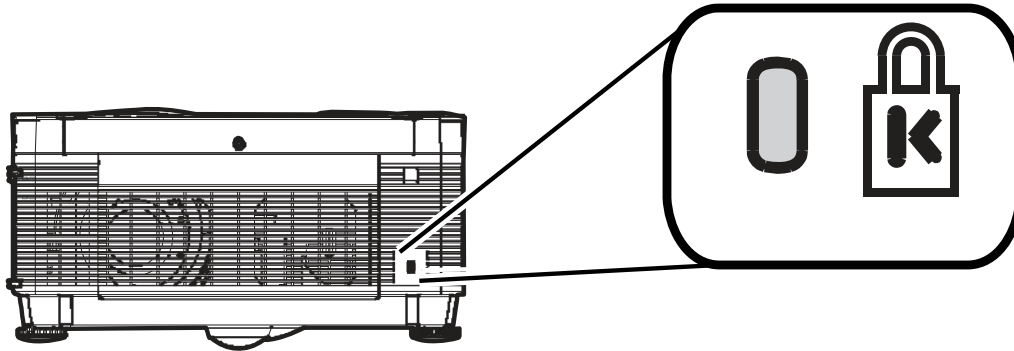

Note:

Contact your vendor for details on purchasing a suitable Kensington security cable.

The security lock corresponds to Kensington’s MicroSaver Security System. If you have any comment, contact: Kensington, 2853 Campus Drive, San Mateo, CA94403, U.S.A. Tel: 800-535-4242, <http://www.Kensington.com>.

Ceiling Installation

We recommend when installing the projector on a ceiling to use the P3025 ceiling mount kit. If you use a different ceiling mount kit, follow the manufacturer’s instructions and ensure qualified personnel install the projector. Ask your dealer for details on purchasing ceiling mount kits and support cables.

Securing the Mount to the Ceiling

When securing the mount to a concrete ceiling, be sure to use expansion screws that can be embedded into the ceiling.

When securing the mount to a wooden ceiling, be sure the ceiling is strong enough and the support screws are appropriate.

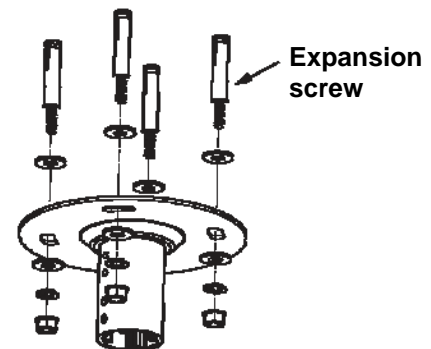

Using Support Cables

For added safety, the projector bracket must be secured with three metal support cables.

The cables should be attached to the projector bracket and secured to the ceiling with expansion screws.

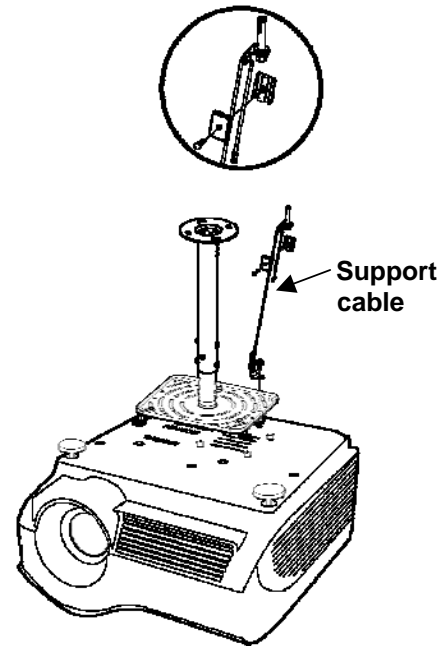

Caution:

For ceiling installations, use approved mounting hardware and M4 screws with a maximum screw depth of 6 mm (1/4 inch). To allow for proper ventilation, keep a distance of 50 cm (20 inches) from walls and ceiling. For permanent installations, follow local codes.

Common problems and solutions

These guidelines provide tips to deal with problems you may encounter while using the projector. If the problem remains unsolved, contact your dealer for assistance.

Often after time spent troubleshooting, the problem is traced to something as simple as a loose connection. Check the following before proceeding to the problem-specific solutions.

- *Use some other electrical device to confirm that the electrical outlet is working.*
- *Ensure the projector is turned on.*
- *Ensure all connections are securely attached.*
- *Ensure the attached device is turned on.*
- *Ensure a connected PC is not in suspend mode.*
- *Ensure a connected notebook computer is configured for an external display. (This is usually done by pressing an Fn-key combination on the notebook.)*

Tips for Troubleshooting

In each problem-specific section, try the steps in the order suggested. This may help you to solve the problem more quickly.

Try to pin point the problem and thus avoid replacing non-defective parts.

For example, if you replace batteries and the problem remains, put the original batteries back and go to the next step.

Keep a record of the steps you take when troubleshooting: The information may be useful when calling for technical support or for passing on to service personnel.

LED Error Messages

LED	STATUS/ NUMBER OF FLASHES	DESCRIPTION
Power	2	I ² C bus error
	3	System over temperature
	4	System I ² C interface error
	5	Lamp error
	6	Fan error
	8	DLP Driver error
Temperature Valid only when fan error	1	Power & Ballast fan
	2	Blower fan (Lamp 2, Right)
	3	Blower fan (Lamp 1, Left)
	4	Outlet fan (Lamp 2, Right)
	5	Blower fan (Rod)
	6	Outlet fan (Lamp 1, Left)
	7	PC board fan
	8	Blower fan (DMD)
	9	Blower fan (DMD)

Image Problems

Problem: No image appears on the screen

1. Verify the settings on your notebook or desktop PC.
2. Turn off all equipment and power up again in the correct order.

Problem: The image is blurred

1. Adjust the **Focus** on the projector.
2. Press the **Auto** button on the remote control or projector.
3. Ensure the projector-to-screen distance is within the 10-meter (33-feet) specified range.
4. Check that the projector lens is clean.

Problem: The image is wider at the top or bottom (trapezoid effect)

1. Position the projector so it is as perpendicular to the screen as possible.
2. Use the **Keystone** button on the remote control or projector to correct the problem.

Problem: The image is reversed or upside down

Check the **Projection** setting on the **Utility** menu of the OSD.

Problem: The image is streaked

1. Set the **Frequency** and **Tracking** settings on the **Utility** menu of the OSD to the default settings.
2. To ensure the problem is not caused by a connected PC's video card, connect to another computer.

Problem: The image is flat with no contrast

Adjust the **Contrast** setting on the **Main** menu of the OSD.

Problem: The color of the projected image does not match the source image.

Adjust the **Color Temperature** and **Gamma** settings on the **Main** menu of the OSD.

Lamp Problems

Problem: There is no light from the projector

1. Check that the power cable is securely connected.
2. Ensure the power source is good by testing with another electrical device.
3. Restart the projector in the correct order and check that the Power LED is green.
4. If you have replaced the lamp recently, try resetting the lamp connections.
5. Replace the lamp module.
6. Put the old lamp back in the projector and have the projector serviced.

Problem: The lamp goes off

1. Power surges can cause the lamp to turn off. Press the power button twice to turn off the projector. When the Power LED is on, press the power button.
2. Replace the lamp module.
3. Put the old lamp back in the projector and have the projector serviced.

Remote Control Problems

Problem: The projector does not respond to the remote control

1. Direct the remote control towards remote sensor on the projector.
2. Ensure the path between remote and sensor is not obstructed.
3. Turn off any fluorescent lights in the room.
4. Check the battery polarity.
5. Replace the batteries.
6. Turn off other Infrared-enabled devices in the vicinity.
7. Have the remote control serviced.

Audio Problems

Problem: There is no sound

1. Adjust the volume on the remote control.
2. Adjust the volume of the audio source.
3. Check the audio cable connection.
4. Test the source audio output with other speakers.
5. Have the projector serviced.

Problem: The sound is distorted

1. Check the audio cable connection.

2. Test the source audio output with other speakers.
3. Have the projector serviced.

Having the Projector Serviced

If you are unable to solve the problem, you should have the projector serviced. Pack the projector in the original carton. Include a description of the problem and a checklist of the steps you took when trying to fix the problem: The information may be useful to service personnel. For servicing, return the projector to the place you purchased it.

SPECIFICATIONS

Specifications

D3355 Dual Lamp System (250W)

Display type	TI DMD 0.7-inch x 1, 12 degrees, DDR DLP with Pixelworks ASIC controller
Resolution	XGA 1024 x 768 native
Color	16.7 Million (24-bits/pixel)
Bandwidth	Up to 205 MHz
Weight	15.5 kg (34.1 lb)
Projection distance	1.5 to 10 meters (4.9 to 32.8 feet)
Projection screen size	1.0 to 7.6 meters (40 inches to 300 inches)
Brightness uniformity	Typical 85%; minimum 75%
Projection lens	Motor zoom and focus
Zoom ratio	1.22:1
Vertical/horizontal keystone correction	+/- 40
Projection methods	Desktop front/rear; ceiling front/rear
Data compatibility	IBM PC or compatibles (VGA, SVGA, XGA, SXGA, UXGA), Mac
SDTV/EDTV/HDTV	480i/p, 576i/p, 720p, 1080i, 1080p (5BNC only)
Video compatibility	NTSC/NTSC 4.43, PAL (B/G/H/I/M/N 60), SECAM
H-Sync	15, 31 - 94 kHz
V-Sync	50 - 85 Hz
Safety certification	FCC Class A, UL, C-UL, CE, CB, TUV, CCC
Operation temperature	5° ~ 35°
Dimensions	See "Projector Dimensions" on page 54
Power consumption	Typical 650W (normal mode); Typical 520W (Eco mode)
Stand By	AC 110V: 2.3W+ (< 3W) AC 220V: 3.4W+ (< 4W)
Lamp	Normal mode: 250W; Eco mode: 200W

Audio speaker	Two 3W stereo speakers
---------------	------------------------

I nput Connectors

Input Data 1	DVI-D (with HDCP)
Input Data 2	BNC x5
Input Data 3	DB-15
Video	(RCA x1)
S-Video	x1
Component Video	Through BNC-to-RCA adapter x3
HDMI Digital Video	x1
Input Audio 1 (RCA R/L)	RCA Jack (R/L) x 3 for Video, S-Video, Component
Input Audio 2 (Mini jack)	Mini Jack x 3 for Data DB-15, DVI, BNC

O utput Connectors

Data output	DB-15 (Loop through)
Audio output	Mini jack for analog

C ontrol Connectors

USB	Type B x1
RS-232	DB-9 x1
Network Control (RJ45)	RJ45 for assets management w/ embedded web server
Option for wireless	RJ45 x1, mini PCI 802.11b/g

O ptional Lens

Model	Throw ratio
GR-1	0.8:1
G-80	1.5 - 1.8: 1
Standard lens	1.8 - 2.25: 1
G-200	2.25 - 3.0 : 1
G-400	3.0 - 4.5 : 1
G-500	4.5 - 7.0: 1

Projection Distance V.S. Projection Size (For standard lens)

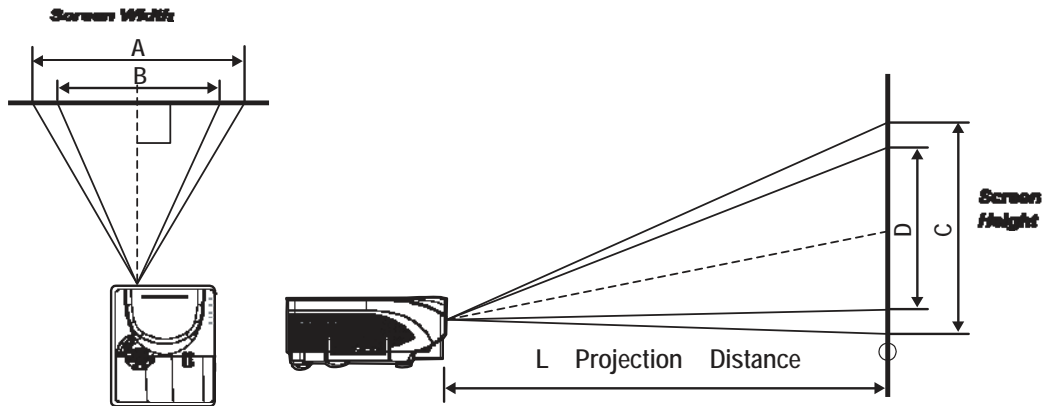

Projection Distance	Max. Screen Size (Wide)			1.8	Max. Screen Size (Tele)	
	Diagonal	Width A	Height C		Diagonal	Width B
2.20 m	1.53 m	1.22 m	0.92 m	--	--	--
7.22'	60.11"	48.09"	36.07"	--	--	--
2.70 m	1.87 m	1.50 m	1.12 m	1.53 m	1.23 m	0.92 m
8.86'	73.77"	59.02"	44.26"	60.39"	48.32"	36.24"
3.20 m	2.22 m	1.78 m	1.33 m	1.82 m	1.45 m	1.09 m
10.50'	87.43"	69.95"	52.46"	71.58"	57.26"	42.95"
3.70 m	2.57 m	2.05 m	1.54 m	2.10 m	1.68 m	1.26 m
12.14'	101.09"	80.87"	60.66"	82.76"	66.21"	49.66"
4.20 m	2.91 m	2.33 m	1.75 m	2.39m	1.91 m	1.43 m
13.78'	114.75"	91.80"	68.85"	93.95"	75.16"	56.37"
4.70 m	3.26 m	2.61 m	1.96 m	2.67 m	2.14 m	1.60 m
15.42'	128.42"	102.73"	77.05"	105.13"	84.10"	63.08"
5.20 m	3.61 m	2.89 m	2.17 m	2.95 m	2.36 m	1.77 m
17.06'	142.08"	113.66"	85.25"	116.31"	93.05"	69.79"
6.20 m	4.30 m	3.44 m	2.58 m	3.52 m	2.82 m	2.11 m
20.34'	169.40"	135.52"	101.64"	138.68"	110.95"	83.21"
7.20 m	5.00 m	4.00 m	3.00 m	4.09m	3.27 m	2.45 m
23.62'	196.72"	157.38"	118.03"	161.05"	128.84"	96.63"
8.20 m	5.69 m	4.55 m	3.41 m	4.66 m	3.73 m	2.80 m
26.90'	224.04"	179.23"	134.43"	183.42"	146.74"	110.05"
9.20 m	6.38 m	5.11 m	3.83 m	5.23 m	4.18 m	3.14 m
30.18'	251.37"	201.09"	150.82"	205.79"	164.63"	123.47"
10.20 m	--	--	--	5.80 m	4.64 m	3.48 m
33.46'	--	--	--	228.16"	182.52"	136.89"
11.30 m	--	--	--	6.42 m	5.14 m	3.85 m
37.07'	--	--	--	252.76"	202.21"	151.66"

Shaded rows are equivalent measurement in feet and inches

Timing Mode Table

The projector can display several resolutions. The following table outlines the resolutions that can be displayed by the projector.

Video format	Frame rate	DSUB15	RGBHV	DVI	HDMI	Component	Video	S-video
VGA 640x350	85	○	○	○	○			
VGA 640x400	85	○	○	○	○			
VGA 720x400	85	○	○	○	○			
VGA 640x480	60	○	○	○	○			
VGA 640x480	72	○	○	○	○			
VGA 640x480	75	○	○	○	○			
VGA 640x480	85	○	○	○	○			
SVGA 800x600	56	○	○	○	○			
SVGA 800x600	60	○	○	○	○			
SVGA 800x600	72	○	○	○	○			
SVGA 800x600	75	○	○	○	○			
SVGA 800x600	85	○	○	○	○			
XGA 1024x768	60	○	○	○	○			
XGA 1024x768	70	○	○	○	○			
XGA 1024x768	75	○	○	○	○			
XGA 1024x768	85	○	○	○	○			
XGA 1024x768	43	○	○	○	○			
1152x864	75	○	○	○	○			
SXGA1280x1024	60	○	○	○	○			
SXGA1280x1024	75	○	○	○	○			
SXGA1280x1024	85	○	○	○	○			
UXGA1600x1200	60	○	○	○	○			
UXGA1600x1200	65	○	○					
UXGA1600x1200	70	○	○					
UXGA1600x1200	75	○	○					
UXGA1600x1200	85							
1792x1344	60	○	○					
1792x1344	75							
1856x1392	60							
1856x1392	75							
1920x1440	60							
1920x1440	75							

Video format	Frame rate	DSUB15	RGBHV	DVI	HDMI	Component	Video	S-video
Apple 640x480	66	○	○	○	○			
Apple 640x870	75	○	○	○	○			
Apple 640x480	67	○	○	○	○			
Apple 832x624	75	○	○	○	○			
Apple 1024x768	60	○	○	○	○			
Apple 1024x768	75	○	○	○	○			
Apple 1152x870	75	○	○	○	○			
1080p	60	○	○					
1080i	60	○	○	○	○			
1080p	50	○	○					
1080i	50	○	○	○	○			
1080p	30	○	○	○	○			
1080p	25	○	○	○	○			
1080p	24	○	○	○	○			
1035i	60							
720p	60	○	○	○	○			
720p	50	○	○	○	○			
720p	30	○	○	○	○			
720p	25	○	○	○	○			
720p	24	○	○	○	○			
480p	60	○	○	○	○			
480i	60			○	○			
576p	50	○	○	○	○			
576i	50			○	○			
480i	60				○			
480p	60				○			
480i	60				○			
480P	60				○			
576i	50				○			
576p	50				○			
720p	60				○			
720p	50				○			
1080i	60				○			
1080i	50				○			
1080p	30							
1080p	25							
1080p	24							

Video format	Frame rate	DSUB15	RGBHV	DVI	HDMI	Component	Video	S-video
720x240P	60							
1440x240P	60							
1440x480P	60							
2880x480i	60							
720x288P	50							
1440x288P	50							
1440x576P	50							
2880x576i	50							
1080p	60	○	○					
1080i	60	○	○			○		
1080p	50	○	○					
1080i	50	○	○			○		
1080p	30	○	○			○		
1080p	25	○	○			○		
1080p	24	○	○			○		
1035i	60							
720p	60	○	○			○		
720p	50	○	○			○		
720p	30	○	○			○		
720p	25	○	○			○		
720p	24	○	○			○		
480p	60	○	○			○		
480i	60					○		
576p	50	○	○			○		
576i	50					○		
NTSC-M	60						○	○
NTSC-J	60						○	○
NTSC4.43	60						○	○
PAL	50						○	○
PAL-M	60						○	○
PAL-N	50						○	○
PAL-60	60						○	○
SECAM	50						○	○

Projector Dimensions

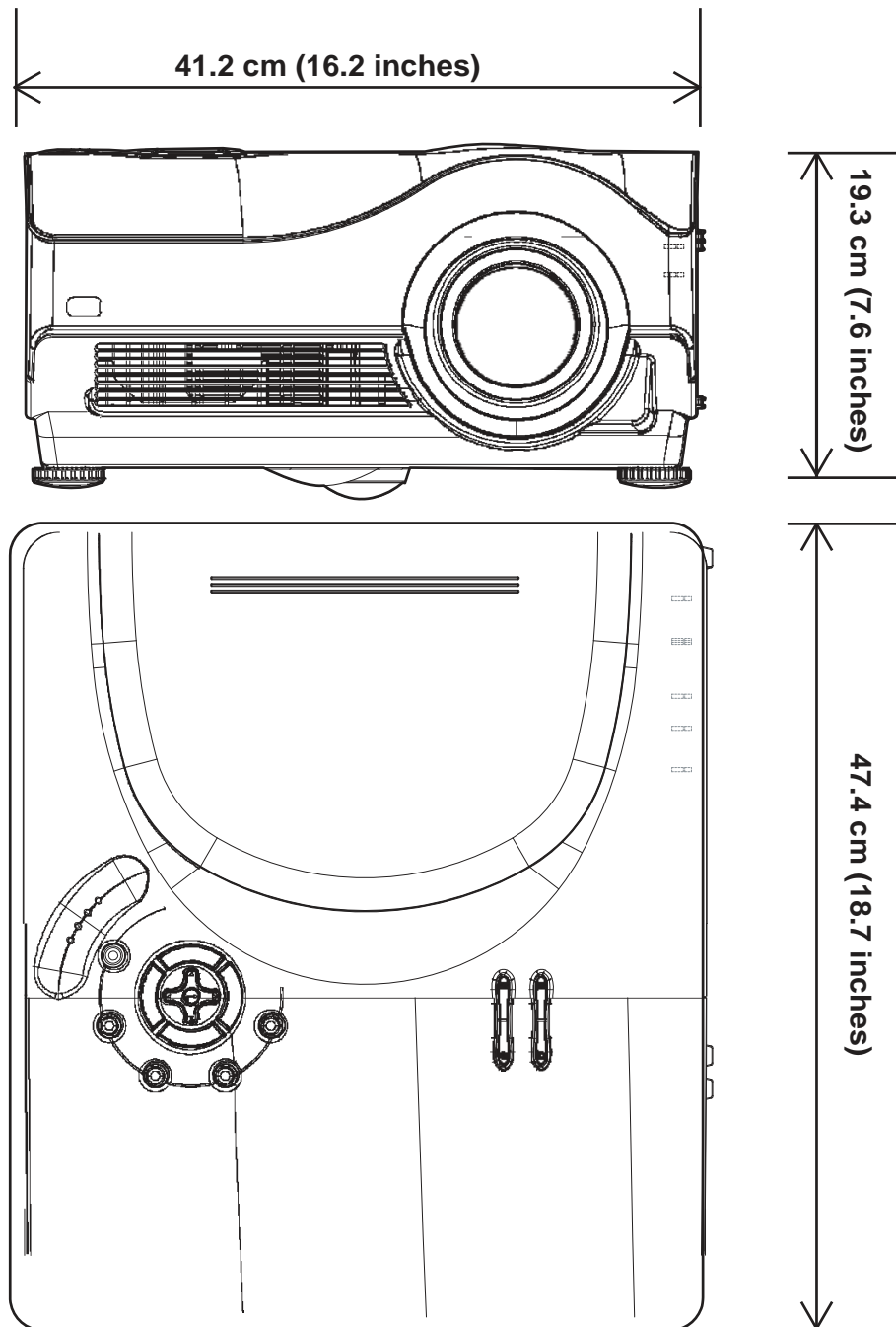

REGULATORY COMPLIANCE

FCC Warning

This equipment has been tested and found to comply with the limits for a Class A digital device pursuant to Part 15 of the FCC Rules. These limits are designed to provide reasonable protection against harmful interference when the equipment is operated in a commercial environment.

This equipment generates, uses, and can radiate radio frequency energy and, if not installed and used in accordance with the instruction manual, may cause harmful interference to radio communications. Operation of this equipment in a residential area is likely to cause harmful interference in which case the user will be required to correct the interference at his own expense.

Changes or modifications not expressly approved by the parties responsible for compliance could void the user's authority to operate the equipment.

Canada

This class A digital apparatus complies with Canadian ICES-003.

Safety Certifications

UL, CUL, CB, TUV-GS, CCC

EN 55022 Warning

This is a Class A product. In a domestic environment, it may cause radio interference, in which case the user may be required to take adequate measures. The typical use is in a conference room, meeting room, or auditorium.